

---

## **AC 2011-1000: ENERGY HARVESTING FOR ENGINEERING EDUCATORS**

### **Eric C Dierks, The University of Texas at Austin**

Mr. Dierks is currently a Master's student at The University of Texas at Austin working on powering structural health monitoring systems through energy harvesting and scavenging. He also earned a BSME from the same university in 2008. Following this he worked for the Institute for Advanced Technology in Austin modeling, simulating, optimizing, and testing battery-inductor pulsed power supplies for electromagnetic rail guns for the US Army and Navy. There, he also briefly served as a reviewer for Carnegie Mellon's autonomous platform demonstrator robotic program.

### **Jason M Weaver, The University of Texas at Austin**

Jason Weaver is a PhD candidate in Mechanical Engineering at The University of Texas at Austin. His current research focuses on the development of energy harvesting technology, with special emphasis on piezoelectric vibration harvesting and functional analysis. Previously, he earned his MS from The University of Texas at Austin and his BS from Brigham Young University.

### **Kristin L. Wood, The University of Texas, Austin**

KRISTIN WOOD is the Cullen Trust Endowed Professor in Engineering and the University Distinguished Teaching Professor at The University of Texas at Austin, Department of Mechanical Engineering. Dr. Wood's current research interests focus on innovative product design, development, and evolution. The current and near-future objective of this research is to develop design strategies, representations, and languages that will result in more comprehensive design tools, innovation processes, innovative manufacturing techniques, and design teaching aids at the college, pre-college, and industrial levels. Contact: wood@mail.utexas.edu

### **Kendra Crider, U.S. Air Force Academy**

Kendra Crider is a major in the US Air Force and an assistant professor at the Air Force Academy in the Engineering Mechanics department. Maj. Crider's areas of interest are in systems engineering, concept generation, students' retention of academic material, and optics. She is currently working with a group of undergraduate capstone students to design and develop an energy harvesting prototype that will be used to power health monitoring systems.

### **Daniel D. Jensen, U.S. Air Force Academy**

Dr. Dan Jensen is a Professor of Engineering Mechanics at the U.S. Air Force Academy where he has been since 1997. He received his B.S. (Mechanical Engineering), M.S. (Applied Mechanics) and Ph.D. (Aerospace Engineering Science) from the University of Colorado at Boulder. He has worked for Texas Instruments, Lockheed Martin, NASA, University of the Pacific, Lawrence Berkeley National Lab and MSC Software Corp. His research includes development of innovative design methodologies and enhancement of engineering education.

# Energy Harvesting for Engineering Educators

## Abstract

Engineering education should include preparing and developing students not only for careers in industry and research currently in demand, but also for those fields and technological areas that are emerging in the near, moderate, and long-term future. This paper serves to provide a cornerstone for engineering educators concerning the emerging and exciting field of energy harvesting such that the subject may be introduced to students who will soon enter industry or academia. An example of its use with senior-level engineering students is then presented. This effort supports, but does not prove, the hypothesis that exposing students to new and upcoming engineering fields, such as energy harvesting, has the potential to plant a seed of inspiration in our students, growing their interest, excitement and dedication to engineering and the service of societal needs.

In conjunction with a foundational overview of the field of energy harvesting aimed at educators and students, the paper includes an exploration of energy harvesters by a group of senior-level engineering undergraduates. The students collaborate on a joint project to innovatively capture energy from the environment to power sensors and transmitters which detect cracks, corrosion, and fatigue in bridges in an automated and high-fidelity fashion, replacing manual inspections. This project exemplifies the energy harvesting field as an exciting educational tool useful for preparing students for careers in industry, consulting, entrepreneurial ventures, or applied research. This paper provides a snapshot of this project and seeks to demonstrate the integration of emerging technology studies in undergraduate curriculum while the students explore a suite of concepts to power health monitoring systems.

## 1: Motivation

It can become easy for a student to become overwhelmed or lose enthusiasm during their undergraduate engineering education; solving problems which have already been implemented in industry for years or working on a project which is not utilized upon completion. On the other hand, need-based problems which offer a greater opportunity for realization are thought to give the student a real-world challenge with a more immediate sense of contribution, resulting in increased enthusiasm for the problem as well as the field<sup>1-3</sup>. Undergraduates across all scientific backgrounds wish to be involved in an area where the results of their efforts are more immediate, yet also make contributions to human needs. The field of energy harvesting offers many need-based problems of this type; it is an emerging and unsaturated field leaving room for less bounded creative exploration of possibilities and more opportunity for contribution. There has been much development in low power computer processing and wireless communication in the past ten years, and there is an ever-growing need for monitoring and automating processes and structures throughout many industrial domains<sup>4</sup>. In combination, these factors produce an area of

great need and promise for future expansion as government and industry wish to increase safety and efficiency while adding precision and reducing human-related error<sup>5, 6</sup>.

Wireless structural health monitoring systems allow for straight-forward installation as long as a wireless power source is available. This is one of the areas where the need for energy harvesting is clear. Batteries powering each sensor, processor, and transmitter/receiver may have to be replaced frequently depending upon the respective power consumption. Furthermore, placement of these systems in remote or hazardous locations make batteries less attractive compared to a system which harvests energy from its immediate environment. Power supplies able to operate for decades at a time, dependent only upon available sources of energy such as light, wind, heat, water, or vibration could give these wireless systems true and far-reaching potential.

With a great many possible sources of energy and even more applications, an energy harvesting project-centered course in engineering may be shaped to match the wide range of interests and backgrounds of the students. Energy harvesting is inherently multidisciplinary in that most systems include mechanical, electrical, and wireless communications components with further diversity within each discipline. For example, the mechanical system could include complex nonlinear dynamics in vibration harvesting, thermodynamics and heat transfer in thermal harvesting, and fluid dynamics in wind harvesting. Electrical components to condition, store, and deliver power to the load may be a mixture of analog and digital, while communications may be performed in a number of frequency bands and network protocols. An educationally diverse team is therefore beneficial. One can envision a student team composed of biomedical, mechanical, electrical, and computer engineering students working on harvesting energy of human walking in an everyday basis to power a user's mobile phone. A project such as this promotes interdisciplinary learning, which has recently been gaining favor in several universities<sup>7</sup>.

In a senior design course students may concentrate on a power source particular to their technical elective courses of interest. For example, a team including a mechanical engineering major focusing on thermal-fluid systems could be given a problem sponsored by an oil company to monitor the corrosion of refinery pipelines by powering sensors from thermoelectric ceramic devices such as the one shown in Figure 1. The temperature difference between the hot fluid in the pipeline and a set of external cooling fins generate a voltage in the ceramic similar in function to a thermocouple. This project would allow the mechanical engineering team member to use his or her specified elective knowledge of thermodynamics and fluid mechanics but in a more novel application whose demand is expected to grow<sup>4</sup>. Figure 2 shows the rapid increase of work in industry and academia on energy harvesting in the past ten years in response to the growth of structural health monitoring and process automation, while focus on lithium batteries, in comparison, is relatively constant over the past twenty years.

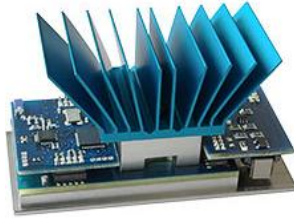

Figure 1. Thermoelectric energy harvester which operates on the Seebeck effect, inducing roughly 1V for every 10° C of temperature difference across the device<sup>8</sup>.

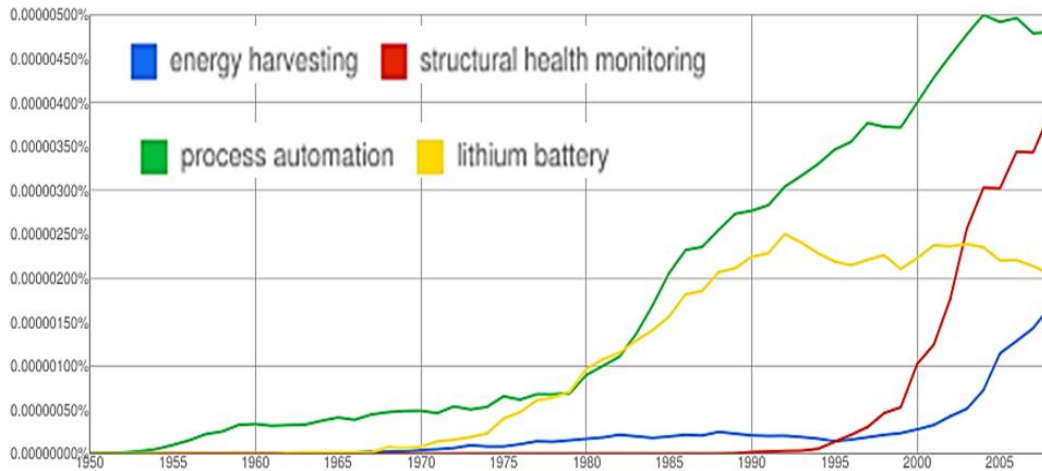

Figure 2. Trends in the fields of energy harvesting, structural health monitoring, process automation, and lithium battery power as percentages of the websites, articles, and books indexed by Google<sup>4</sup>.

An issue arises based on the limited amount of time and resources in a semester or two consecutive semesters to work in an emerging subject area. Background information on the basics and the history of the field must be known to make a significant contribution with the project. Students need a knowledge base to steepen the learning curve at the beginning of the process so they may make a noteworthy contribution, resulting in a sense of satisfaction with increased enthusiasm. Figure 3 helps to visualize the predicted effect upon the standard learning curve, where the vertical dashed lines denote the point where the student transitions his or her focus from learning to producing. According to Psychology professor Dr. Russ Dewey, “The S-shaped learning curve is most obvious when someone learns a highly complex task. The initial part of the curve rises slowly as a person becomes familiar with the basic components of a skill. The steep ascending phase occurs when there is enough experience with the rudiments or simple components to start ‘putting it all together.’ Rapid progress follows until the skill ‘hits a ceiling’ or stabilizes at a high level”<sup>9</sup>. A structured introduction with identification of important papers will help here and reduce the chance of a student becoming overwhelmed. The following section is an overview of energy harvesting to form a knowledge base for just this purpose.

Predicted Improvement with Learning Module

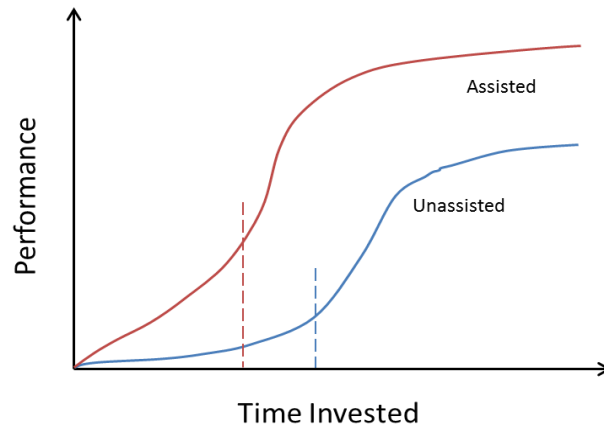

Figure 3. Visualization of a typical learning curve and one altered by the effect of an organized introduction to the field<sup>9</sup>.

## 2: Energy Harvesting Knowledge Base

Energy harvesting encompasses any method for capturing energy from the harvester's immediate surroundings and converting it into a useful form of energy, often electrical, to be used usually within close proximity of its source. Energy harvesting differs from large-scale alternative energy production like wind farms in that the scales of the harvesters and their respective power levels are relatively small, and the energy is captured close to where it is used. Some of the major types of energy harvesting include capturing power from solar radiation (through photovoltaic cells or solar heat engines), wind and other flowing fluids (through turbines or airfoil flutter), vibration (through piezoelectric, electrostatic, or electromagnetic transducers), thermal (through thermoelectric ceramics, turbines, or sterling engines), human (through electromechanical devices such as bicycle mechanisms, hand-driven cranks, or motion-conversion and storage systems) and ambient electromagnetic radiation (through radio waves picked up by antennae). A sub-category of energy harvesting is energy scavenging, which involves capturing ambient energy that is not regularly predictable with ease, is only available in short bursts or emissions over long time periods, or would otherwise go unused and lost as waste heat or noise<sup>10</sup>. An example of energy scavenging is the concept of a vehicle detection system in a rural or military environment where wireless communications are powered by the vibrations of the passing vehicles. These scavengers could lie dormant for years until activated, consuming no power until needed.

### 2.1: Energy Sources

Many energy sources exist for a given application. A visualization of many found in a search of literature and commercial products is given in Figure 4 in the form of a mind map<sup>11, 12</sup>. In this mind map, the energy domain is given as a node and the energy sources for that domain are given as branches from that node. Although the figure does not claim to be comprehensive;

identifying every possible source of energy for harvesting, it does span a large segment of the available sources pertaining to energy harvesting. This mind map, and those found later in this paper, serve to give students a broad overview of the possibilities that may be chosen for investigation as a solution to their application.

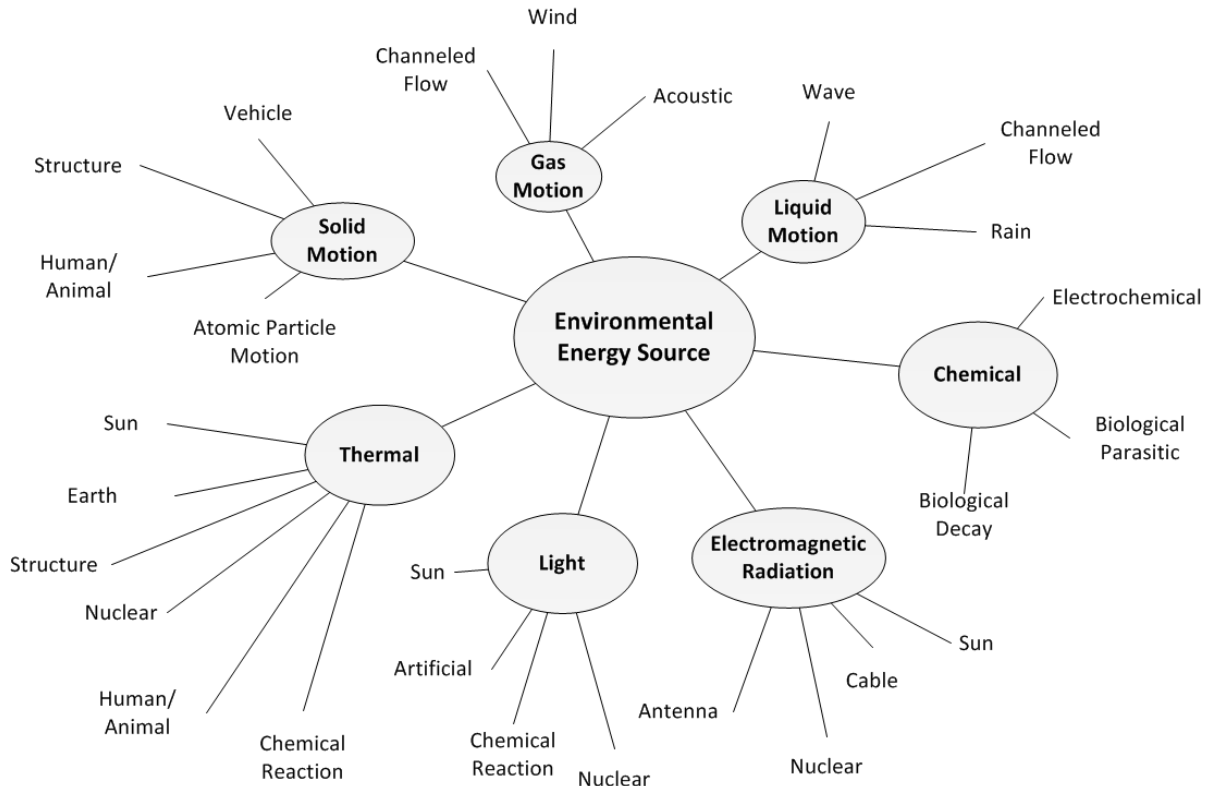

Figure 4. Mind map of energy sources organized by energy domain.

Some of the sources may require additional explanation for clarity, such as *Atomic Particle Motion*. A harvester was found that uses radiated atomic particles building up on a cantilevered beam, deflecting it and dislodging, causing the beam to spring upward and oscillate<sup>13</sup>. Additionally, *Biological Parasitic* refers to extracting metabolic energy from living matter, such as plants or animals, in a parasitic manner but without killing the organism. A commercially available harvester was found which claims to be powered from tree roots for forest fire monitoring<sup>14</sup>.

To narrow the scope of possible solutions, it is necessary to determine which, if any, of the categories of harvesters are feasible given current technological and operating conditions of application. One area of feasibility is the harvester’s ability to provide sufficient power to the load. The first step in determining power feasibility is an understanding of the environmental energy available for harvesting. Because energy harvesters may be scaled up or down to match the required power, a useful metric for comparison is power density. This metric is the power the system can provide, normalized by area, volume, or mass depending upon the system and information available. The theoretical maximum power density can be determined from the

fundamental equations or models describing each harvesting process. These theoretical maximums must also be compared to the actual power densities observed in baseline commercial and experimental energy harvesters to be fully reliable. An initial summary of the power densities of some energy harvesting technologies is presented in Table 1. These simplified calculations are based upon the primary power equations for each domain, which are used to predict theoretical and practical maximums with common parameters. Several more possibilities of harvesters exist than are given in Table 1. For example, studies of energy harvesting from the human body are not included, but are available<sup>15-17</sup>.

Table 1. Power densities of several energy harvesting sources<sup>18</sup>.

Model	Theoretical Max	Practical Max	Parameters
$P=\eta EA$	100 mW/cm <sup>2</sup>	3,750 μW/cm <sup>2</sup>	1 kW/m <sup>2</sup> irradi., 15% eff., 6 hr. insol.
$P=0.5\rho Sv^3C$	4.45 mW/cm <sup>2</sup>	380 μW/cm <sup>2</sup>	5 m/s, 5% conversion eff.
$P=m\zeta_e A^2/4\omega\zeta_T^2$	19 mW/cm <sup>3</sup>	300 μW/cm <sup>3</sup>	Tungsten mass, 1 Hz, .01 $\zeta_e$ , .02 $\zeta_T$
$P=0.5\rho Sv^3C$	3.7 W/cm <sup>2</sup>	67 μW/cm <sup>2</sup>	5 m/s, 5% conversion eff.
$P=\eta_C k\Delta T/L$	117 mW/cm <sup>2</sup>	40 μW/cm <sup>2</sup>	5°C differential, silicon, 1 cm length
$P=\eta EA$	5 mW/cm <sup>2</sup>	10 μW/cm <sup>2</sup>	Shade reduces both irradi. & eff.
$\Delta E=mR\Delta T$	17 μW/cm <sup>3</sup>	3 μW/cm <sup>3</sup>	helium, 10°C temp change/day
$P=P_0\lambda^2/4\pi R^2$	50 μW/receiver	2 μW/receiver	1 W transmitter, 5 m away, 2.4 GHz
$P=A_c E_e$	1.6x10 <sup>6</sup> W/cm <sup>3</sup>	0.52 μW/cm <sup>3</sup>	<sup>63</sup> Ni activating an oscillator
$I=P_{ac}/4\pi R^2$	0.96 μW/cm <sup>2</sup>	0.1 μW/cm <sup>2</sup>	100 dB

## 2.2: Energy Conversion

A mind map of energy conversions between domains is given in Figure 5. The domains are represented as nodes and the mechanisms for converting between domains are represented as lines linking the nodes. The choice of conversion mechanism will affect the power density for the harvester, so a careful study of the advantages and disadvantages particular to the application should be included in the decision process. A brief introduction to most of these conversions as well as the energy sources of Figure 4 follows, with emphasis on those most commonly used today. Links to manufacturers of many kinds of energy harvesters and accessories, as well as more detailed information may be found in the Energy Harvesting Forum<sup>19</sup> and Energy Harvesting Journal<sup>20</sup>.

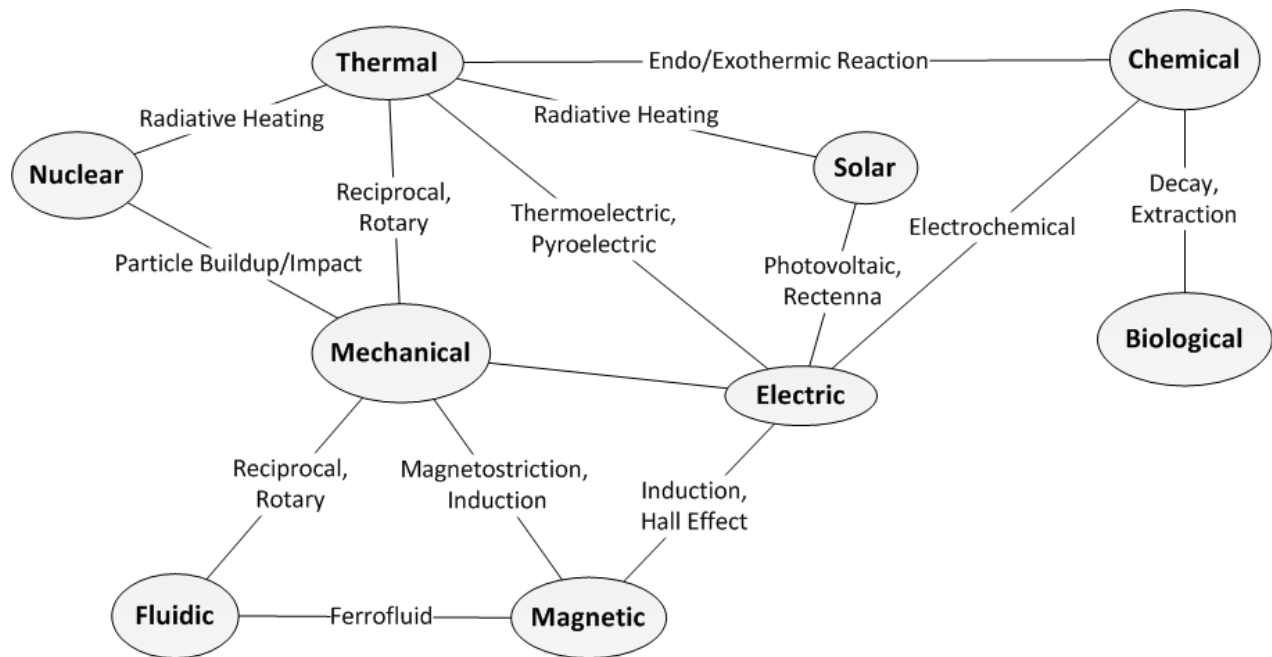

Figure 5. A map of transduction mechanisms for converting between energy domains.

### 2.2.1: Solar Energy Harvesting

As shown in Table 1, photovoltaic (PV) solar power is by far the most power dense, surpassing wind and vibration by an order of magnitude. The power available from solar irradiation is governed by the relationship:

$$P = \eta EA_{cell} \quad (1)$$

where  $P$  is the power output (W),  $\eta$  is the efficiency,  $E$  is the solar irradiation ( $\text{W}/\text{m}^2$ ), and  $A_{cell}$  is the area of the photovoltaic cell ( $\text{m}^2$ ). The current maximum efficiencies for PV technologies are 25% for single-crystal silicon, 20% for thin-film silicon, and claims of more than 40% for multiple-junction cells<sup>21</sup>. Most economical PV panels use poly-crystalline, thin-film, or amorphous silicon and exhibit efficiencies ranging from 5% to 15%. Recently, flexible photovoltaic cells have been developed and are now commercially available, allowing a decrease in required storage volume<sup>22</sup>. One advantage of photovoltaic cells, besides the high power density, is no rectification circuit is needed as the voltage out is DC.

The most significant parameter in characterizing a solar energy source is solar irradiance, measured in watts per square meter. Long-term levels of solar energy are described by comparing the total irradiance per day to an equivalent number of hours at a constant irradiance of  $1,000 \text{ W}/\text{m}^2$ . This is called the solar insolation. Solar irradiance is commonly measured with a lux meter. Long-term average insolation is available in the literature for most major U.S. cities for both summer and winter<sup>23</sup>. Levels of solar irradiation vary in the short-term due to weather patterns and seasonal variation, but long-term average levels are reasonably consistent and well



documented<sup>23</sup>. This makes sizing a system for a given power output a straightforward process of gathering data on irradiation in the area, determining voltage and current needs, and specifying the appropriate size of solar panels and battery.

Solar technology does have several shortcomings concerning some applications. A first concern is maintenance. Solar panels designed for outdoor use often have estimated lives of twenty years or more, but they may require periodic cleaning or other maintenance. In many circumstances occasional rain is sufficient to remove dust, but panels may be subject to much higher levels of debris ranging from grease and dirt to animal droppings, bird nests, and litter. Precaution should also be used in environments where hail occurs regularly. A second concern is the need for direct sunlight to operate at peak capacity. In the shade, both the available irradiation and the panel efficiency itself drastically decrease. For example, measurements taken by the authors showed irradiation levels of 1,132 W/m<sup>2</sup> in direct sunlight, but only 3-15 W/m<sup>2</sup> in the shade. Because of this result, the use of solar panels is largely confined to locations where direct sunlight is available often.

A solar nantenna is a nanometer-scale antenna and rectifier array which captures light in a similar way that radio waves are received in a car's antenna. Light delivers more energy than radio waves since the energy contained in an electromagnetic wave increases with the frequency of the wave. At this time this device is not practical as diodes for rectification have not yet been able to operate at such high frequencies<sup>24</sup>. Future implementations of nantennas are expected to be very power dense, and continuing research is progressing to make them a reality.

### 2.2.2: Wind Energy Harvesting

Small-scale wind-turbines have not yet found widespread use compared to large power generation turbines. The power available from the kinetic energy of wind is governed by the relationship

$$P = \frac{1}{2} \rho S v_1^3 C_p \quad (2)$$

where  $P$  is the power output (W),  $\rho$  is the density of the air (kg/m<sup>3</sup>),  $S$  is the effective cross-sectional area of the turbine (m<sup>2</sup>),  $v_1$  is the initial velocity of the air entering the turbine (m/s), and  $C_p$  is the efficiency of the system. Betz's Law limits this efficiency to a maximum of 59.3%, with large-scale turbines often operating in the range of 30-50%<sup>25</sup>. Small-scale turbines usually have much lower efficiencies, usually around 5-10%. Since wind is often intermittent, the average power harvested by a wind turbine should be adjusted for its environment. The capacity factor is a common way to evaluate the level at which the turbine is performing in its environment, and is defined as the ratio of actual output power to output power at full capacity, over a set time period. Typical wind farms have capacity factors ranging from 20-40%<sup>26</sup>.

Rotational turbines are available in two main categories: horizontal axis wind turbines (HAWTs) and vertical axis wind turbines (VAWTs)<sup>27, 28</sup>. HAWTs rotate about axes parallel to

the airflow. They are more efficient, but only operate in one direction without a yaw mechanism to turn the blades towards the wind, as shown on the left of Figure 6. VAWTs rotate about axes perpendicular to the airflow. Such turbines are slightly less efficient, but they are omnidirectional; their effectiveness is not dependent on wind direction and are therefore better suited to variable winds. In addition, many can operate at lower wind speeds than HAWTs. VAWTs come in many varieties, such as those shown on the right of Figure 6. In addition to these two turbine types, an airfoil may be used which flutters in the wind, allowing vibration harvesting methods to be used to further capture the energy in a compact volume<sup>29</sup>.



Figure 6. Examples of some commercially available wind turbines<sup>30-33</sup>.

The potential limitations of using wind turbines are similar to those presented by photovoltaic panels. Maintenance is a key issue, even more so here than with solar panels as turbines have exposed moving parts which can easily be damaged or clogged. Designing a small, inexpensive turbine that can reliably last many years without maintenance may be difficult. Also, like solar panels, wind turbines are dependent on the predictable availability of power. Some may be in locations where wind is channeled in predictable and relatively constant patterns but others may only sporadically encounter wind. Ducting may be used to guide the wind through the turbine, but usually at the cost of becoming more directional. Power derived from the wind is proportional to the velocity cubed, so brief but powerful gusts may be preferable over constant but weak breezes. Thus, the feasibility of using wind power must be evaluated on a location-by-location basis by evaluating wind speeds with an anemometer. Hourly, daily, and long-term average wind velocities are also available for many geographic locations in the literature<sup>34</sup>.

### 2.2.3: Vibration Energy Harvesting

The conversion between mechanical vibration and electricity has been used for some time in microphones, speakers, accelerometers, geophones, and seismographs; however optimization of this technology for energy harvesting is a relatively recent development. The fundamental relationship describing the theoretical power available in a vibration harvesting system with a simple sinusoidal input acceleration at mechanical resonance is

$$P = \frac{m\zeta_E a^2}{4\omega(\zeta_E + \zeta_M)^2} \quad (3)$$

where  $P$  is the power output,  $m$  is the vibrating mass in the harvester,  $a$  is the magnitude of acceleration experienced by the mass,  $\omega$  is the frequency of the acceleration (with the harvester designed to vibrate at the same natural frequency), and  $\zeta_E$  and  $\zeta_M$  are the electrical and mechanical damping coefficients. This equation shows the general need to maximize mass and amplitude, minimize the difference between the harvester natural frequency and the lowest excitation frequency with appreciable amplitude, and minimize mechanical damping<sup>13</sup>.

The three most common methods of vibration energy harvesting are electromagnetic, piezoelectric, and electrostatic. Electromagnetic harvesting operates using Faraday's Law of Induction; a changing magnetic flux will induce a voltage in a closed loop of conductor. In practice, this is usually accomplished by moving a magnet and a coil relative to each other to produce an AC voltage in the coil. This technology is currently used with great success in motion-powered flashlights and watches, as well as commercially available and research vibration harvesters as shown in Figure 7.

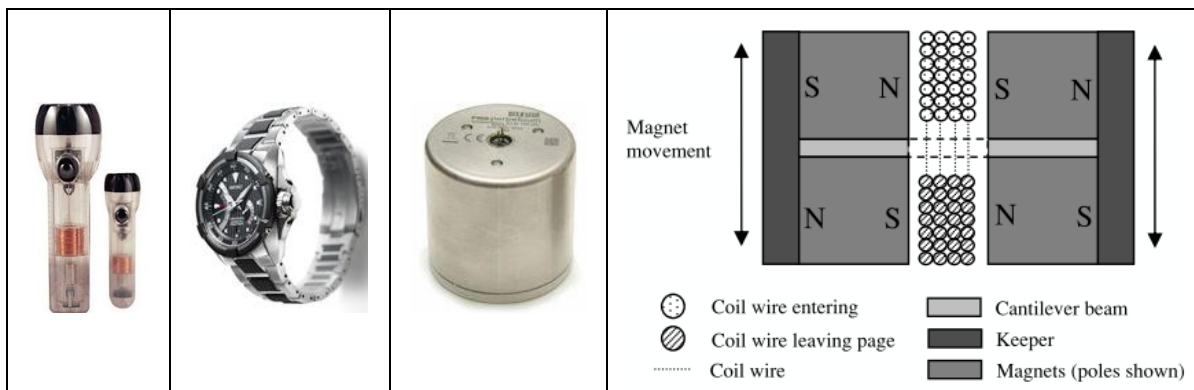

Figure 7. Examples of inductive vibration harvesters: (From left to right) Faraday flashlights<sup>35</sup>, Seiko Kinetic Drive watch<sup>36</sup>, Perpetuum PMG37 micro-generator<sup>37</sup>, schematic of the University of Southampton research harvester<sup>38</sup>.

In a piezoelectric material, an applied mechanical strain in the material creates an electric field giving a voltage across its electric terminals. The typical embodiment is a cantilever beam with a mass at the tip and piezoelectric ceramic or film attached to the upper and lower faces of the beam<sup>39</sup> such as in Figure 8. As the beam vibrates, the two films undergo cyclical tension and compression, generating an AC voltage. Piezoelectric energy harvesters are often used instead of inductive harvesters when one of the conditions is true:

- The application is too small to economically manufacture an inductive system.
- The frequency of the input vibration is in the hundreds or thousands of Hz.
- The vibrations of interest are intermittent, and the energy is harvested as isolated impulses, impacts, or shocks.

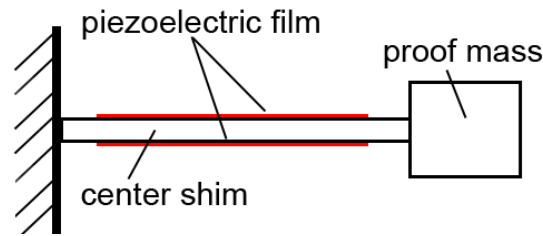

Figure 8. Bimorph cantilever piezoelectric harvester.

Electrostatic harvesters are capacitors which change either the gap distance or normal area of opposite electrically charged plates<sup>13</sup> as shown in the schematic on the left of Figure 9. Most require a “polarization” voltage to be applied to the plates before energy may be harvested, which is a significant disadvantage, but Electrets may be used to supply this voltage without an external source. The Electret substance is deposited upon the plates during manufacture and provides the polarization voltage eliminating this disadvantage<sup>40</sup>. Electret microphones have existed for some time but application to energy harvesting has not yet been found by the authors.

Other less common methods of vibration harvesting are the use of magnetostrictive and electrostrictive materials as well as magnetostrictive-piezoelectric hybrids. Magnetostrictive and electrostrictive materials strain when exposed to varying magnetic or electric fields, respectively<sup>41</sup>. A simple magnetostrictive harvester contains a bar of Terfenol-D surrounded by a coil across which a voltage is induced when the straining bar changes the magnetic field in the coil<sup>42</sup>. In a slight alteration a magnetostrictive-piezoelectric hybrid delivers a voltage from a piezoelectric crystal which is strained by the magnetostrictive material when it is exposed to a moving magnet<sup>13</sup> such as shown in the schematic on the right of Figure 9.

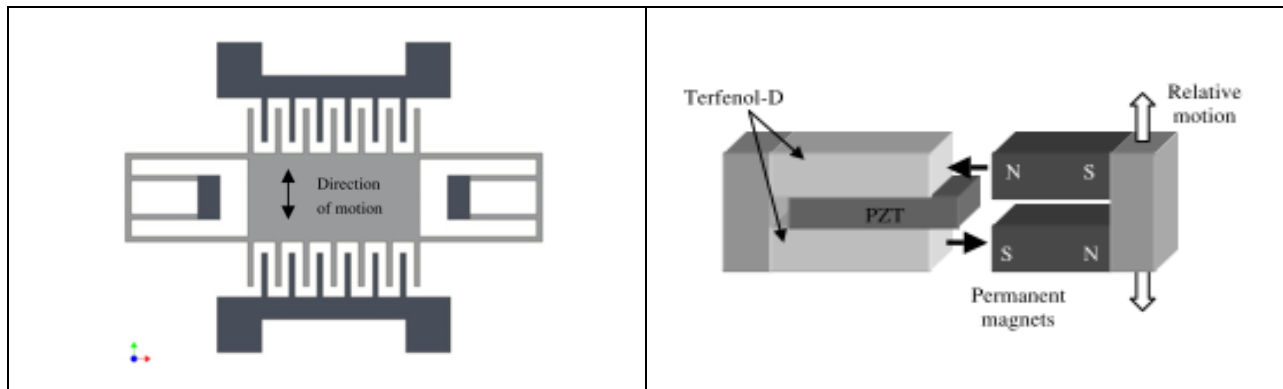

Figure 9. Schematic of an electrostatic vibration energy harvester (left)<sup>13</sup> and schematic of a magnetostrictive-piezoelectric vibration energy harvester (right)<sup>13</sup>.

### 2.3: Energy Storage

The harvested energy may be stored in a number of ways. A visualization of those found in a detailed search of literature and commercial products is given in Figure 10 in the form of a mind map. Once considering the many possible methods to store the harvested energy, the best choice must be made by considering the power and energy require by the load as well as the

maximum allowable volume. A storage method may be energy dense but if that energy cannot be delivered at the desired power level then the method cannot be successfully used. The best way to determine which methods are suitable is to compare their power and energy densities, which will allow the user to estimate the volume that will be required. Figure 11 presents both values for common storage methods. The values of compressed air are lacking in Figure 11 but may be found in the literature<sup>43,44</sup>.

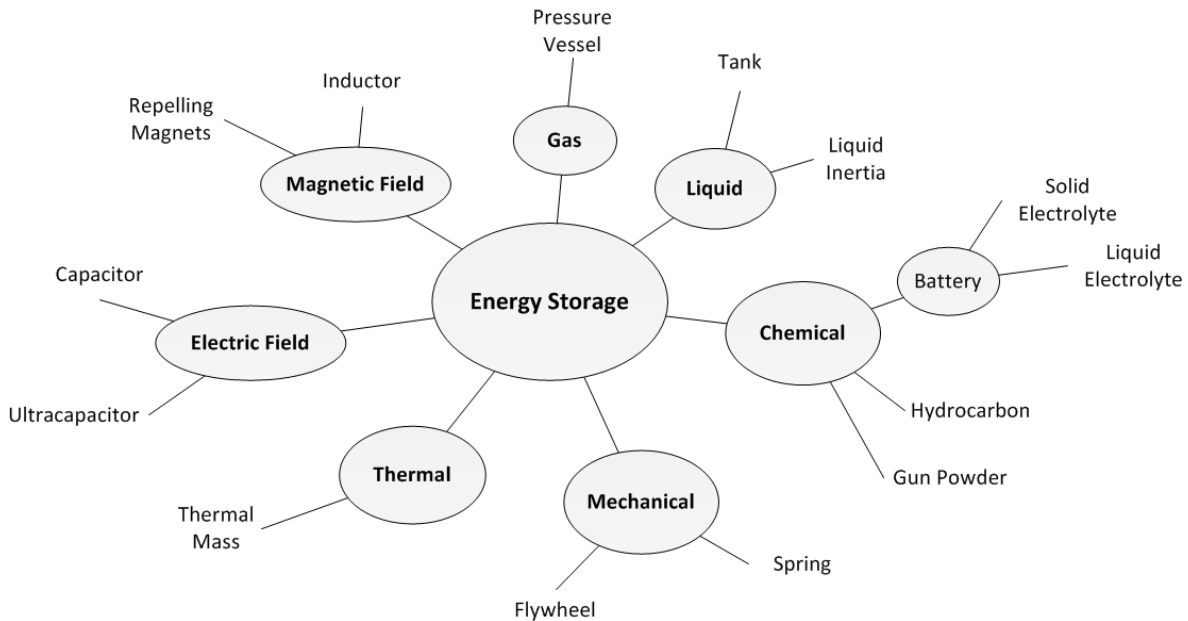

Figure 10. Mind map of energy storage methods by energy domain.

An extensive look into energy storage methods may be found in the text titled Energy Storage by Huggins<sup>45</sup>. The most commonly used method is the liquid electrolyte battery such as your typical Lithium-ion or Nickel Metal-Hydride battery available from SAFT<sup>46</sup> or A123<sup>47</sup>. Table 2 provides a comparison between the various types of batteries currently on the market. Lead acid batteries are used in gasoline-powered cars, while Ni-MH and Li-ion are more common in consumer electronics. Lithium-ion batteries necessitate protection as if they are either discharged completely or over heated the battery could be ruined and no longer hold a charge<sup>48</sup>. Therefore an additional chip must be used to manage the charge and temperature of the battery, but these are often included with the battery system. Solid state lithium ion batteries, which are not included in Figures 11-12 or Table 2, have a solid electrolyte and offer significantly longer life but are still fairly small in capacity. Infinite Power Solutions<sup>49</sup> and Cymbet<sup>50</sup> sell the new batteries utilizing nanometer-scale channels preventing the cathode and anode from contacting via dendrites which build up over time rendering a battery unable to hold charge.

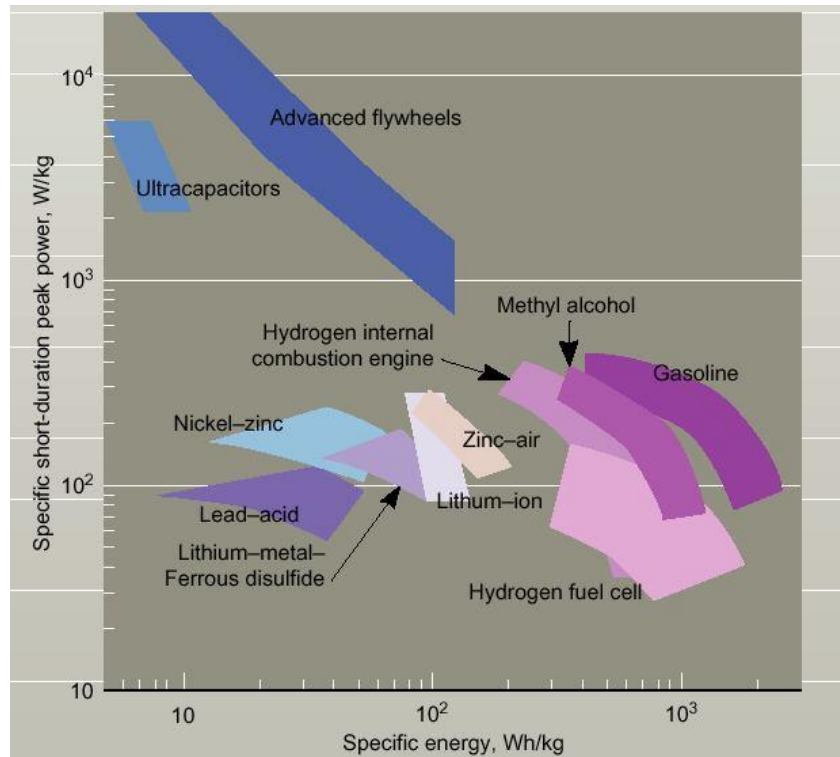

Figure 11. Power density of various energy storage methods<sup>51</sup>.

Table 2: Battery Performance Comparison<sup>52</sup>.

Items	Li-ion	Ni-MH	Lead-acid
Working voltage (V)	3.7	1.2	2.0
Gravimetric energy density (Wh/kg)	130~200	60~90	30~40
Volumetric energy density (Wh/L)	340~400	200~250	130~180
Cycle life (cycles)	500	400	300
Capacity self discharge rate (% per month)	5%	30%	10%
Memory effect	None	40%	None
Energy efficiency ( $C_{\text{discharge}}/C_{\text{charge}}$ )	99%	70%	75%
Weight comparison for the same capacity	1	2	4
Size comparison for the same capacity	1	1.8	3.5
Reliability	High	Low	High

Figure 12 compares the energy densities and power densities of additional battery types to those of regular electrolytic capacitors and double layer ultracapacitors (aka supercapacitors), which are missing from Table 2. Ultracapacitors are attractive because they charge and discharge quickly and have a longer cycle life. Maxwell is one manufacturer of ultracapacitors for all uses<sup>53</sup>.

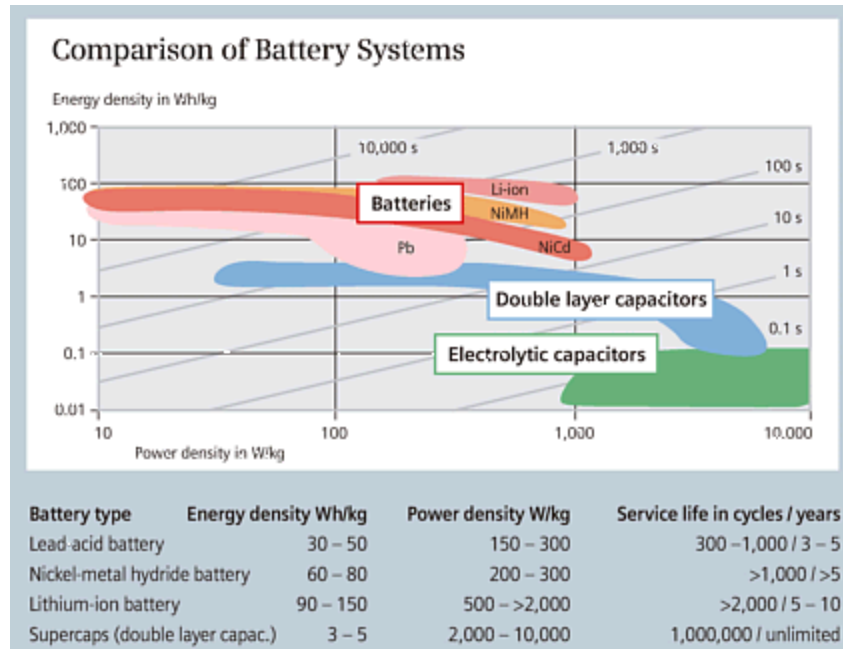

Figure 12: Comparison of Supercapacitors and batteries<sup>54</sup>.

## 2.4: Future Innovations in Energy Harvesting

Future innovations may be in the hybrid use of several energy harvesting/scavenging technologies collaboratively in one package, as well as systems of harvesters in separate packages which network to capture energy in a more efficient, strategic, or constant manner. Solar cells and wind turbines may supply energy when it is available with electromagnetic generators supplying a continuous flow. Solutions which include new functions like pre-harvesting preparation, adaptation to changes in the source, robust handling of uncertainty, built in sensing, and protection would have significant impact on the field. Solar cells may be fitted with concentrating lenses, sun-tracking equipment, and adaptive protection while vibration harvesters may be fitted with self-tuning and bandwidth widening capabilities<sup>55</sup>.

## 3: Project-centered Learning Case for Energy Harvesting

Energy harvesting was incorporated into the Capstone Design course at the United States Air Force Academy in the 2009-10 academic year by Dr. Dan Jensen. The project-centered course focuses on identifying and developing innovative opportunities to harvest energy in order to power structural health monitoring systems on highway bridges. Wireless sensor nodes are used to acquire and transmit strain, crack, and corrosion data to a host computer offsite. This type of project is of particular interest as much of the nation's infrastructure necessitates frequent and costly inspection to monitor deterioration, and thus has wide-ranging consequences.

The inclusion of an energy harvesting project into the Capstone Design course met no notable challenges to implementation and was well received by other faculty. The specific learning objectives of the course include working through a typical engineering design process,

including background research, concept generation and selection, embodiment, formulation and accomplishment of an analysis plan, prototype construction, and formulation and accomplishment of a test plan. Along the way, students are to present their work to the department head and faculty through preliminary and critical design reviews as well as update the project sponsor on their progress.

Interdisciplinary collaboration was implemented by including Mechanical Engineering, Electrical Engineering, and System Engineering Management students. The mechanical students primarily deal with concept generation, static and dynamic stresses, guidance of ambient energy to the conversion mechanism, and protection from environmental effects such as corrosion. Electrical students primarily work on the conversion of the mechanical energy to electrical energy, its conditioning, storage, and integration with specific sensors and the wireless network. System Engineering Management students primarily respond to customer needs and integrate the two disciplines while keeping the team on schedule and on budget. Each student was involved in all aspects of the project with focus on the primary duties of their respective discipline.

A collaborative environment was created with energy harvesting graduate students at the University of Texas at Austin to provide a view of research in the field at a graduate level as well as to foster undergrad-grad mentoring. The interaction from the graduate students also provided specifications on the sensors and transmitters the harvesters would be powering as well as additional technical advice. The graduate students were involved in the development of additional, separate energy harvesters for their own research, which provided experiences to share with the cadets. The only notable challenge to their collaboration was distance, as the undergraduate-only Air Force Academy is located in Colorado Springs, Colorado and the graduate students are in Austin, Texas. The graduate students traveled a few times over the past two years to talk in person with the undergraduate students and see their prototypes. This academic year, much collaboration has happened over video conferencing using Skype, which has worked very well.

### **3.1: Description of Undergraduate Student Work**

The 2009-10 undergraduate team performed extensive concept generation using the design methods taught in class, which follow the text of Otto and Wood<sup>56</sup>. A total of 40 concepts were generated and narrowed down to a Piezoelectric Vertical Axis Wind Turbine. The team built and evaluated a prototype of the piezoelectric VAWT which is comprised of three piezoelectric strips distributed 120° apart within a cylindrical housing. A set of strikers deflect the piezoelectric strips as the shaft is rotated by a 5 blade Darrieus-type wind turbine (Figure 13). The piezoelectric strips are connected in parallel to a full-wave rectifier to convert the AC voltage to DC for storage into a large capacitor (Figure 14). Additional circuitry including a DC to DC voltage regulator controls power delivery to the load, which was a National Instruments Wireless Sensor Node (WSN).



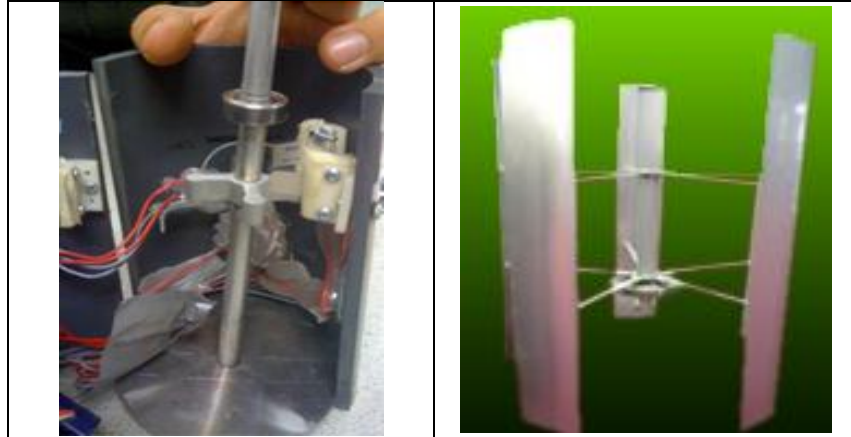

Figure 13. Internal view of harvester (left) and turbine blades (right).

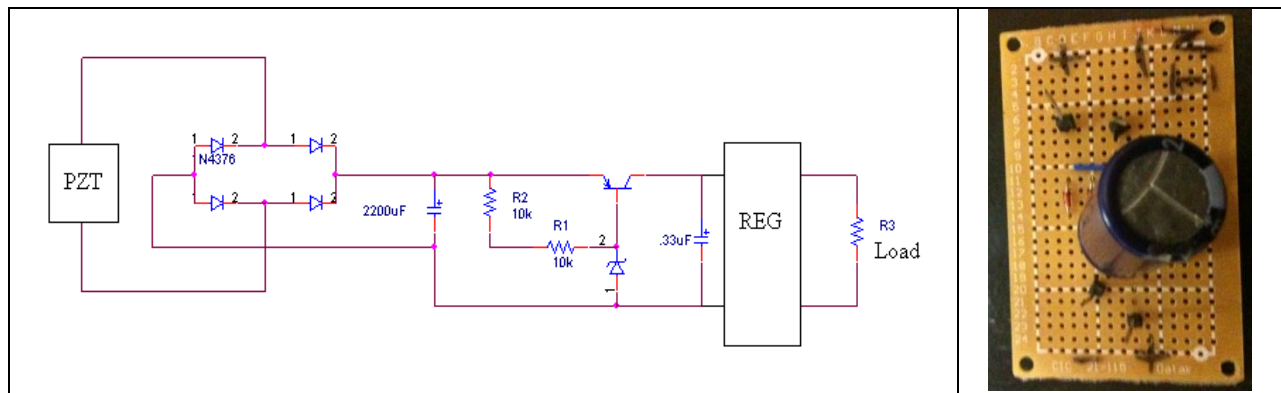

Figure 14. Circuit schematic (left) and completed circuit (right).

The utilization of piezoelectric strips in place of a generator was pursued as a new concept which seemed to be better low wind speed option. The torque on the shaft was predicted to be lower than with a generator, ideally allowing the turbine to harvest low speed wind. The VAWT was tested with a fan delivering a velocity of 13 mph, which was the one month average wind speed found during data collection at the USAFA cadet airfield. Testing was performed using an open circuit as the load to characterize the harvester independently. The testing results are summarized in Table 3.

Table 3. Summary of piezoelectric VAWT test results.

Charge Rate	250µJ/min
Maximum Output Voltage	1.5V
Minimum Wind Speed Necessary	6.8 mph
Maximum Safe Wind Speed	35 mph
Energy for WSN Cycle: power on, sample once, transmit, power off	10.7mJ
Charging Time per WSN Cycle	45 min

The wireless sensor node requires 6V to operate, but with the current system able to produce only 1.5 V, refinements to the voltage regulation circuit are needed to complete the

system. Time for this task ran out for the 2009-10 academic year, giving inspiration for the creation of this paper for the purposes of supplying the undergraduates with a broad introduction to energy harvesting in hopes of increasing productivity in subsequent years. Work on this paper was conducted during the 2010-11 academic year, so the new class of cadets has not yet been provided this resource.

In the meantime, the project continued in the 2010-2011 school year with a new undergraduate design team. The goals for this team were to develop an alternative method to harvest energy, improve the past year's VAWT, and mount the two harvesters to a local bridge. The team went through a similar design process, narrowing down to two designs. The first is a flag in which piezoelectric strips are sown to generate power when the flag waves in the wind, taking advantage of light and variable winds. The second is a hydraulic tube which is placed on the road surface and converts the pressure change in the tube to electricity when driven over by traffic (Figure 15).

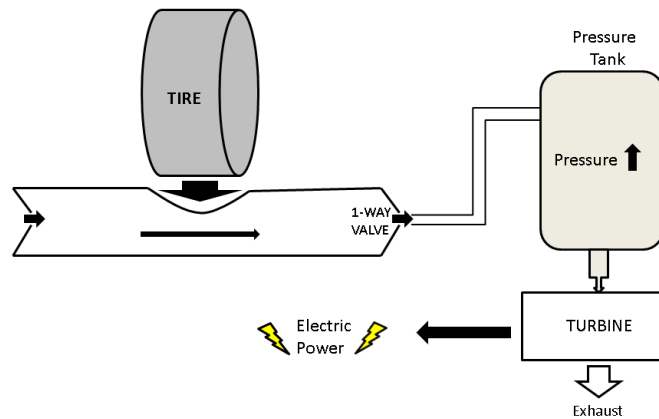

Figure 15. Preliminary pressure tube concept.

The design has evolved to include a piston, rack and pinion system, and electric generator in place of the pressure tank and turbine. The electrical energy will then be rectified and stored in a battery in a very similar fashion to the VAWT. Additionally, several hoses will be used rather than one single hose. This design was chosen for prototyping and is currently under construction.

Feedback from faculty at USAFA and the sponsor have been positive in relation to the student's contributions and progress within one academic year. A structured evaluation of the student opinion on the effects of the project on their interest and enthusiasm for engineering has not yet been performed, but casual conversations are promising. Evaluation before and after introducing the energy harvesting knowledge base at the beginning of the semester will hopefully give further merit. Generating the knowledge base resource was the primary task at hand during this phase, and expansion on the overview of energy harvesting will continue.

#### **4: Final Thoughts**

Energy harvesting will be of ever increasing importance as costs for mainstream energy rise and increasing instrumentation of structures for safety and efficiency continue. One could wonder how efficient electronics and machines would become and the corresponding reduction in energy needs on a large scale if every device needing power could only rely on its immediate environment. The distribution of energy generation even in small amounts could eventually make a significant impact in cost, robustness, and efficiency upon our energy needs for the better. Engineering students shown an emerging field may have more of an opportunity to contribute in their career, and a dedicated study for this would be a welcome contribution. The authors encourage incorporating a new field like that of energy harvesting into the classroom and lab. The collaborative sharing of information for educational purposes is mutually beneficial to all parties. An organized introduction to a new field can be very beneficial in the learning process and lead to more contribution to the field and satisfaction by the participants. The overview of energy harvesting presented in this paper is a start and the material could be developed and matured into a dynamic and long-lasting learning module. The student projects will continue over the next few years with the implementation of the overview of energy harvesting included in this paper early in the semester. These projects have allowed the students the opportunity to apply discipline-specific academics to a real world application, and future feedback from the students will help to show its effects.

#### **Acknowledgements**

This work is partially supported by the Office of the Secretary of Defense: Corrosion Policy as well as by the National Institute for Standards and Technology: Technology Innovation Program. The work is also sponsored by the United States Air Force Academy: Department of Engineering Mechanics. In addition, we acknowledge the support of the University of Texas at Austin: Department of Mechanical Engineering. Any opinions, findings, or recommendations are those of the authors and do not necessarily reflect the views of the sponsors.

#### **Bibliography**

1. Green M, Dutson A, Wood KL. Integrating Service-Oriented Design Projects in the Engineering Curriculum. In: *ASEE Annual Conference, 2002*. Montreal, Quebec: American Society for Engineering Education; 2002.

2. Green M, Wood KL, VanderLeest S. Service-Learning Approaches to International Humanitarian Design Projects: Assessment of Spiritual Impact. In: *Proceedings of the 5th Christian Engineering Education Conference*. Salt Lake City, Utah; 2004:19-34.
3. Bhandari A, Jones SA, Clapp LW, Fennell DE, LaPara TM. Diversity in Environmental Engineering—Successes and Challenges. *Journal of Environmental Engineering*. 2006;132(7).
4. Google. Google Labs Books Ngram Viewer. 2010. Available at: <http://ngrams.googlelabs.com/> [Accessed 2010].
5. Pisano GP, Shih WC. Restoring American Competitiveness. *Harvard Business Review*. 2009;(July-August):114-125.
6. Duderstadt JJ (chair). Committee to Assess the Capacity of the United States Engineering Research Enterprise, Engineering Research and America's Future: Meeting the Challenge of a Global Economy. 2005.
7. Bender M, Fulwider M, Stemkoski MJ. Linking Project-Based Interdisciplinary Learning And Recommended Professional Competencies With Business Management Digital Media, Distance Learning, Engineering Technology, And English. *Journal of College Teaching & Learning*. 2008;5(5):1-8.
8. Micropelt. Energy Harvesting with Micropelt Thermogenerators. Available at: [http://www.micropelt.com/applications/energy\\_harvesting.php](http://www.micropelt.com/applications/energy_harvesting.php) [Accessed January 2, 2011].
9. Dewey RD. The Learning Curve. In: *Psych Web*: Available at: [http://www.psywww.com/intropsych/ch07\\_cognition/learning\\_curve.html](http://www.psywww.com/intropsych/ch07_cognition/learning_curve.html) [Accessed November 1, 2011].
10. Priya S, Inman DJ eds. *Energy Harvesting Technologies*. 1st ed. Springer; 2008.
11. Weaver JM. Xmarks Shared Bookmarks Folder: Literature Review A. Available at: <http://share.xmarks.com/folder/bookmarks/xAUnqum8uE> [Accessed January 19, 2011].
12. Dierks EC. Xmarks Shared Bookmarks Folder, Literature Review B. Available at: <http://share.xmarks.com/folder/bookmarks/iaJ2yLUUbD> [Accessed January 19, 2011].
13. Beeby SP, Tudor MJ, White NM. Energy harvesting vibration sources for microsystems applications. *Measurement Science and Technology*. 2006;17(12):R175-R195.
14. Voltree Power. Bioenergy Harvester. 2009. Available at: <http://voltreepower.com/bioHarvester.html> [Accessed January 12, 2011].
15. Starner T. Human-powered wearable computing. *IBM Systems Journal*. 1996;35(3):618-629.

16. Saez MLM. Energy Harvesting from Passive Human Power. *Wearable Computers*. 2004;(January).
17. Annalisa Bonfiglio eds. *Wearable Monitoring Systems*. Springer; 2010.
18. Weaver JM, Crawford RH, Wood KL. Design of Energy Harvesting Technology: Feasibility For Low-Power Wireless Sensor Networks. In: *ASME 2010 International Design Engineering Technical Conferences & Computers and Information in Engineering Conference*. Montreal: ASME; 2010:1-10.
19. Energy Harvesting Forum. List of Manufacturers. Available at: <http://www.energyharvesting.net/> [Accessed January 2, 2011].
20. IDTechEx. Energy Harvesting Journal. 2011. Available at: <http://www.energyharvestingjournal.com/?sessionid=1> [Accessed March 20, 2011].
21. Solar Panel Center. Types of Solar Panels. Available at: <http://www.solarpanelcenter.net/Types-of-Solar-Panels.php> [Accessed March 7, 2011].
22. Silicon Solar. Flexible Solar Panels - Consumer Ready Modules - OEM. Available at: <http://www.siliconsolar.com/flexible-solar-panels.html> [Accessed November 1, 2011].
23. Sundance Power Systems Inc. Solar Insolation for U.S. Major Cities. 2011. Available at: <http://www.sundancepower.com/pdf/solarInsolation.pdf> [Accessed March 7, 2011].
24. Kotter DK, Novack SD, Slafer WD, Pinhero P. Solar Nantenna Electromagnetic Collectors. In: *2nd International Conference on Energy Sustainability, ASME.*; 2008:1-7.
25. Khaligh A, Onar OC. *Energy Harvesting: Solar, Wind, and Ocean Energy Conversion Systems*. Taylor and Francis; 2009:350.
26. Renewable Energy Research Laboratory: University of Massachusetts at Amherst. Wind Power: Capacity Factor, Intermittency, and what happens when the wind doesn't blow? Available at: [http://www.ceere.org/rerl/about\\_wind/RERL\\_Fact\\_Sheet\\_2a\\_Capacity\\_Factor.pdf](http://www.ceere.org/rerl/about_wind/RERL_Fact_Sheet_2a_Capacity_Factor.pdf) [Accessed March 7, 2011].
27. SkyDrill Power Systems. HAWT vs. VAWT. Available at: <http://www.skydrill.net/HAWT-vs-VAWT> [Accessed December 1, 2011].
28. New Energy Watch. VAWT Versus HAWT Wind Power. Available at: [http://www.newenergywatch.com/2006/11/vawt\\_versus\\_haw.html](http://www.newenergywatch.com/2006/11/vawt_versus_haw.html) [Accessed January 12, 2011].
29. Humdinger Wind Energy LLC. Windbelt Innovation: Overview. Available at: [http://www.humdingerwind.com/#/wi\\_overview/](http://www.humdingerwind.com/#/wi_overview/) [Accessed March 7, 2011].

30. Sunforce Products Inc. Sunforce 400-Watt Wind Generator. Available at: <http://www.sunforceproducts.com> [Accessed December 1, 2011].
31. Wikipedia Contributors. Darrieus Wind Turbine. *Wikipedia, The Free Encyclopedia*. 2005. Available at: <http://en.wikipedia.org/wiki/File:Darrieus-windmill.jpg> [Accessed March 6, 2011].
32. Helix Wind. S322 Turbine. Available at: <http://www.helixwind.com> [Accessed December 1, 2011].
33. Windspire Energy. Windspire Wind Turbine. Available at: <http://www.windspireenergy.com> [Accessed December 1, 2011].
34. National Climatic Data Center. Online Climate Data Directory. Available at: <http://lwf.ncdc.noaa.gov/oa/climate/climatedata.html> [Accessed March 6, 2011].
35. ToolStore. Faraday Flashlight. Available at: <http://homebuildshoptools.com> [Accessed December 1, 2011].
36. Seiko. Kinetic Watch. Available at: [http://www.seikowatches.com/technology/kinetic/kinetic\\_dd.html](http://www.seikowatches.com/technology/kinetic/kinetic_dd.html) [Accessed December 1, 2011].
37. Perpetuum. Perpetuum PMG37 Micro-generator. Available at: <http://www.perpetuum.com/pmg37.asp> [Accessed December 1, 2011].
38. Beeby SP, Torah RN, Tudor MJ, et al. A micro electromagnetic generator for vibration energy harvesting. *Journal of Micromechanics and Microengineering*. 2007;17(7):1257-1265.
39. Mide. Vulture Vibration Energy Harvesters. Available at: [http://www.mide.com/products/vulture/vulture\\_catalog.php](http://www.mide.com/products/vulture/vulture_catalog.php) [Accessed December 1, 2011].
40. Baxter LK. *Capacitive Sensors: Design and Applications*. John Wiley and Sons; 1996:320.
41. Wang ZL, Kang ZC. *Functional and Smart Materials: Structural Evolution and Structure Analysis*. Springer; 1998:514.
42. Ueno T, Summers E, Wun-Fogle M, Higuchi T. Micro-magnetostrictive Vibrator Using Iron-Gallium Alloy. *Sensors and Actuators A: Physical*. 2008;148(1):280-284.
43. Paloheimo H, Omidiora M. A Feasibility Study on Compressed Air Energy Storage System for Portable Electrical and Electronic Devices. *2009 International Conference on Clean Electrical Power*. 2009:355-362.
44. Wikipedia Contributors. Energy Density. *Wikipedia, The Free Encyclopedia*. Available at: [http://en.wikipedia.org/w/index.php?title=Energy\\_density&oldid=416391847](http://en.wikipedia.org/w/index.php?title=Energy_density&oldid=416391847) [Accessed March 7, 2011].

45. Huggins RA. *Energy Storage*. Springer; 2010:406.
46. SAFT. Saft Batteries. 2007. Available at: <http://www.saftbatteries.com/> [Accessed January 19, 2011].
47. A123 Systems. A123 Systems. 2007. Available at: <http://www.a123systems.com/> [Accessed January 19, 2011].
48. Pistoia G. *Batteries for portable devices*. Elsevier; 2005:296.
49. Infinite Power Solutions. Infinite Power Solutions. 2010. Available at: <http://www.infinitepowersolutions.com/> [Accessed January 19, 2011].
50. Cymbet. Cymbet EnerChip Solid State Energy Storage for Thin Film Batteries and Power Management. 2011. Available at: <http://cymbet.com/> [Accessed January 19, 2011].
51. Rutman J. Magnetic Bearings: Theory and Practice, More or Less... 2004. Available at: [http://physics.technion.ac.il/~rutman/jeremy's seminar.html](http://physics.technion.ac.il/~rutman/jeremy's%20seminar.html) [Accessed January 2, 2011].
52. Electric-Auto. Comparison of Different Battery Technologies. Available at: <http://electric-auto.org/viewtopic.php?f=5&t=4> [Accessed January 2, 2011].
53. Burke A. Ultracapacitors: why, how, and where is the technology. *Journal of Power Sources*. 2000;91(1):37-50.
54. Gerl B. Piggybanks for Power. *Pictures of the Future: Materials for the Environment: Energy Storage*. 2007. Available at: [http://www.siemens.com/innovation/en/publikationen/publications\\_pof/pof\\_fall\\_2007/materials\\_for\\_the\\_environment/energy\\_storage.htm](http://www.siemens.com/innovation/en/publikationen/publications_pof/pof_fall_2007/materials_for_the_environment/energy_storage.htm) [Accessed January 2, 2011].
55. Zhu D, Tudor MJ, Beeby SP. Strategies for increasing the operating frequency range of vibration energy harvesters: a review. *Measurement Science and Technology*. 2010;21(2):022001.
56. Otto KN, Wood KL. *Product Design: Techniques in Reverse Engineering and New Product Development*. Prentice Hall; 2001:1071.