

## **Design and Development of a Teaching Apparatus for Undergraduate Vibration Education through Capstone Design Project**

**Dr. Wooram Park, University of Texas at Dallas**

Wooram Park is an associate professor of instruction in the Department of Mechanical Engineering at University of Texas at Dallas. Prior to joining UT Dallas in 2011, he was a postdoctoral fellow in Mechanical Engineering at Johns Hopkins University. He received his PhD degree in Mechanical Engineering from Johns Hopkins University in 2008. He also received the B.S.E. and M.S.E. degrees in Mechanical Engineering from Seoul National University, Seoul, Korea, in 1999 and 2003, respectively. He received the IEEE Transactions on Automation Science and Engineering Best Paper Award in 2015. He is a member of IEEE and ASME.

He is interested in education of engineering students with the emphasis on robotics and control systems. His research mainly concerns various theoretic problems in robotics such as path planning and kinematic modeling.

# **Design and development of a teaching apparatus for undergraduate vibration education through capstone design project**

## **Abstract**

This paper documents our effort to improve learning experience for students in mechanical vibration class by designing and developing a teaching apparatus. In general, an undergraduate level vibration class covers various vibration phenomena including free vibrations and forced vibrations. Since the vibratory dynamic system generally consists of a mass, a spring, and a damper and its governing equation is a second order differential equation, most lecture contents are developed to provide the analytic analysis using challenging mathematical approaches. Even though this theoretic approach provides academic and practical advantages for students, many students struggle to achieve intuitive understanding on how real vibratory systems behave. It is even more challenging to connect the analysis results and the physical behaviors of vibration systems. To help these students, we designed and developed a teaching apparatus through a capstone design project in the department. In the one-year design project, a group of seniors designed a rotational vibratory system with springs and a torsional damper. Moment of inertia, stiffness and damping are all adjustable so the user can test various vibration conditions such as under-damping, over-damping, critical damping as well as forced vibrations. The system was also designed to be affordable. The apparatus was demonstrated in the class and was evaluated in a student survey. To promote the adoption of the proposed apparatus, the list of components is provided in this paper.

## **I. Introduction and motivation**

An undergraduate vibration course is one of the most important and useful classes in most mechanical or civil engineering departments. It usually covers analysis and control of free and forced vibrations that are often found in machines and buildings. To help students understand vibration phenomena in such complex dynamic systems, most vibration classes start with simple 1DOF or 2DOF systems and associated analysis tools are developed as mathematical methodologies [1].

Even though a simple mass-spring-damper system with 1DOF serves as a helpful starting point for students to learn about vibration phenomena, heavy use of mathematics sometimes makes it more challenging for them to intuitively understand physical vibration motions. In addition, students have different experiences and backgrounds, so we cannot assume that all the students can easily imagine and understand the dynamic motion of a vibrating system and apply analysis methods to the vibratory system. This limitation becomes worse when instructors use only traditional teaching methods such as static figures and pictures, verbal explanations and reading materials.

To improve teaching efficiency and learning experience in a vibration class, various teaching methods have been developed and applied. In [2], tools that demonstrate how viscous dampers work were developed and assessed. McDaniel et al. [3] introduced a full-scale vibration facility

to show students building vibrations. This work was unique and enhanced students' physical understanding of vibration phenomena. However, the development of large-scale vibration structure is unattainable in most departments due to the limited space and cost. Vibration can be demonstrated using computer simulation such as in [4][5]. Computer simulation is easy to implement at low cost, but there is a limit on providing intuitive and direct understanding better than physical vibration systems. Moreover, simulation results cannot reflect the uncertainty and disturbance that physical systems always include. In [6], a combination of simulation, animation, and experimentation is suggested to help students understand the theory of vibration. In [7] and [8], authors suggested that students can learn vibrations through projects. Some educational devices for vibration classes are also available in the market as shown Fig. 1. A downside of these apparatus is that the system is complex and hard to intuitively understand. In addition, the price is one of the reasons that they are not popular in the classroom.

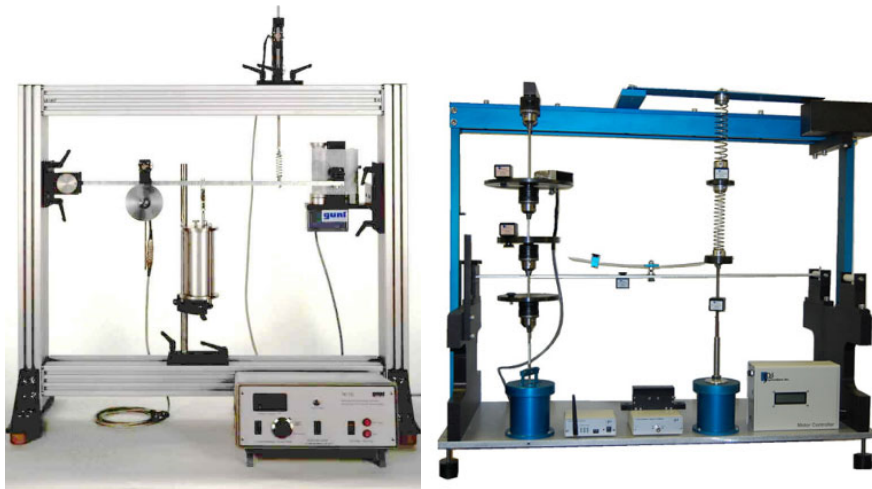

Figure 1. U.S. Didactic's TM 155 Apparatus (left), and SpectraQuest's Vibration System (right)

Although the approaches mentioned above may work well in particular situations such as with sufficient financial support, available space and maintenance, we need to make effort to customize the existing methods or create new approaches because departments offering a vibration class have different limitation and situation, such as funds, spaces, and credit hours assigned to the class.

The goal of the work presented in this paper is to develop an educational vibration apparatus and use it to improve the teaching efficiency and learning experience in the vibration course. Even though the apparatus could be developed by the course instructor with or without the teaching assistant, developing the educational device could be also a good opportunity for senior students to learn design process with the purpose of better education. With this idea, the author created a senior design project to design and build an educational vibration apparatus. Then, it was used in the vibration class, and the student survey was conducted to get ideas to improve the device for the future.

## II. Requirements for design project

Before we defined the design project, we clarified the course contents in the vibration class which would be demonstrated using the educational apparatus. We chose 1DOF free and forced vibrations as the main topics.

In 1DOF free vibrations, the dynamic system is modeled using a mass, a spring and a damper as shown in Fig. 2.

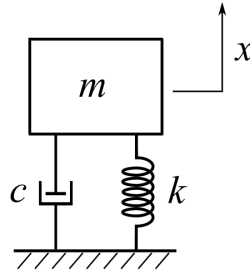

Figure 2. A mass-spring-damper system with 1DOF

The dynamics equation is written as

$$m\ddot{x} + c\dot{x} + kx = 0$$

where  $x$  is the displacement. The parameters  $m$ ,  $c$ , and  $k$  are mass, damping, and stiffness, respectively. This system can be categorized into three groups depending on the system parameters: over-damped, critically damped, under-damped systems. In addition, the vibration motions are distinct depending on the type of the system. In the vibration class, it is expected that students can distinguish the vibration motion based on the system types. To help students, the educational apparatus should clearly demonstrate three types of motions. Therefore, the parameters of the apparatus should be adjustable so the user can determine the system's type.

In addition to free vibrations, the educational apparatus should demonstrate the forced vibrations. The associated vibration system can be modeled as shown in Fig. 3.

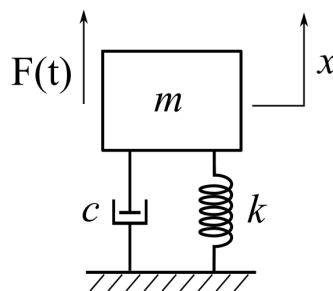

Figure 3. A mass-spring-damper system with 1DOF under external force  $F(t)$

A general vibration class covers various forcing conditions such as harmonic force, non-harmonic periodic force, and general force. However, applying time-varying force function in a physical system is quite challenging, and it increases the cost of the device. As an alternative approach, the system with a moving base is used as shown in Fig. 4.

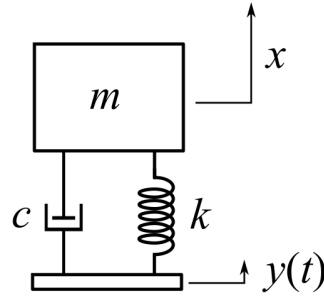

Figure 4. A mass-spring-damper system with 1DOF with a moving base

When a harmonic motion  $y(t) = Y\sin(\omega t)$  is applied to the base, the dynamics equation can be derived as follows.

$$m\ddot{x} + c(\dot{x} - \dot{y}) + k(x - y) = 0$$

$$m\ddot{x} + c\dot{x} + kx = c\dot{y} + ky = \sqrt{c^2\omega^2 + k^2} \cos(\omega t + \phi)$$

Therefore, the motion of the mass-spring-damper system with a moving base heavily depends on the motion parameters of the base, amplitude  $Y$  and frequency  $\omega$ . This system is practical and easy to demonstrate in the device that we develop because the harmonic motion can be obtained from a simple rotation motion of a motor. Like the free vibration demonstration, the parameters of the device should be adjustable in vibration demonstration with the moving base.

The author worked with his department to create a design project for a senior design team. The author's engineering school has been operating a well-established capstone design program for senior students in engineering departments. We used the design education program as a vehicle to implement the educational apparatus. In the one-year course, the author played the role of client, and the student team carried out the design task with the allowed budget \$2,000. For practical use of the device for the vibration course, the device should be deliverable on a cart by one person.

### III. Design details

#### 1. Type of motion

Most theoretic foundation for vibration education starts from a simple system with a linear motion as shown in Fig. 2. However, as will be discussed in the next subsection, the viscous linear dampers with the suitable size for this work are not popular in the market while there are some options for torsional dampers with adjustable damping. For this work, the rotation motion is utilized for the demonstration of the device. As a result, the moment of inertia and equivalent torsional stiffness are considered with the torsional damping in the design of the educational device.

#### 2. Dampers

The first option for the damper that the design team discussed was making fluid dampers. The mass spring system would be immersed in a tube of liquid. As the system moves, the mass would

experience viscous force resisting the movement. This option was not chosen because of the potentially large size of damper and the concern about the leak of fluid.

The next option for the damper in consideration was a magnetic damper. Under Lenz law, an aluminum piece moving through a magnetic field will experience resistance magnetic force. This option would fit the design requirements as the distance between the magnet and the aluminum mass could be adjusted, allowing for an adjustable damping constant. Through a series of tests with neodymium magnets, we found that while the force due to the magnetic field was linear with respect to the velocity of the oscillating mass, the damping force would not be large enough without exceeding the project's size, weight, and cost restraints.

We found that linear dampers were hard to manufacture and small size linear dampers with adjustable damping constant are not available in the market within the allowed project time frame. To overcome this limit, a rotation motion was considered because torsional dampers are relatively easy to obtain.

For rotational damping, a simulated damper based on an encoder and a motor was also considered. An encoder can be used to detect the rotational motion, and the circuit calculates the input current for the motor, so it generates the damping torque that is proportional to the angular velocity. The downside of the simulated damper was that it would be more difficult for students to intuitively understand the dynamic system. Since the source of damping in classical mechanical systems is usually friction or viscosity, use of electrical system to simulate the damping effect makes learning more complex.

The final choice for the damper was the rotational damper with adjustable damping constant as shown in Fig. 5. The torsional damping constant can vary from 0.8 to 10 in·lb/rad/sec with the chosen rotational damper. Other parameters such as moment of inertia and torsional stiffness are determined using the range of the damping in the next subsection.

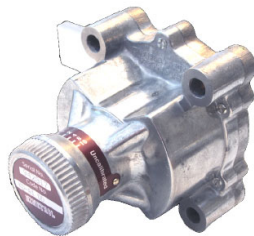

Figure 5. EFDYN Rotational Damper, model # KD-A1-DD

### *3. Structure design*

Due to the choice of the adjustable rotational damper, the apparatus system uses the rotational motion for the demonstration. To build a second order system with rotational motion, a horizontal metal bar was assembled with additional mass, linear springs, and a torsional damper as shown in Fig. 6.

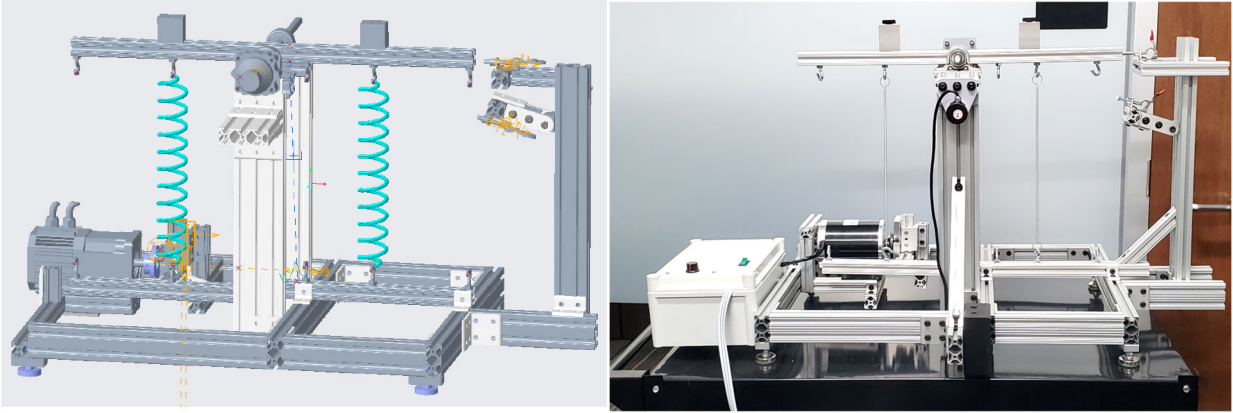

Figure 6. Design of the vibration apparatus

A shaft is attached at the center of the horizontal bar, and it is supported by bearings that are fixed on the vertical frame. The torsional damper is also attached to the shaft. Additional mass blocks were attached to the bar and their location is adjustable. Two linear springs are attached between the horizontal bar and the bottom part of the fixed frame. These springs provide the torsional stiffness to the rotational vibration system.

Fig. 7 shows the modeling of the system for free vibration.

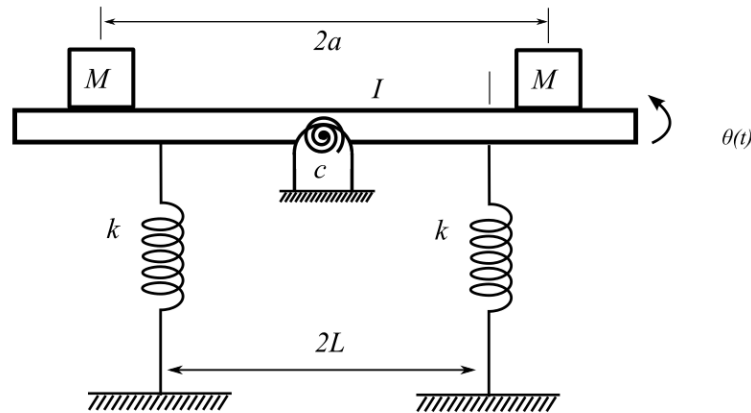

Figure 7. Modeling of the system for free vibrations

The dynamics equation is written as

$$(I + 2Ma^2)\ddot{\theta} + c\dot{\theta} + 2kL^2\theta = 0.$$

The critical damping condition can be written as

$$c_c = 2\sqrt{(I + 2Ma^2) \times 2kL^2}.$$

Since the chosen torsional damper can provide the damping constant between 0.8 to 10 in·lb/rad/sec, reasonable values for mass  $M$ , lengths  $a$  and  $L$ , stiffness  $k$  can be chosen through trial and error. Other damping conditions can be achieved by changing the lengths  $a$  and  $L$ , or adjusting the damping constant  $c$ . Through this reasoning, we chose  $M = 0.8$  lb,  $L = 6$  or  $12$  in,  $a = 0\sim 10$  in, and the spring constant  $0.31$  lb/in for the device. Note that the lengths for  $L$  and  $a$  are

not fixed. Since the apparatus should be able to show different damping conditions, the locations of the spring and the mass can be adjusted.

To test the forced vibration, a motor with the Scotch-yoke mechanism was used. The motor provides the harmonic motion of the left base. The system model is shown in Fig. 8.

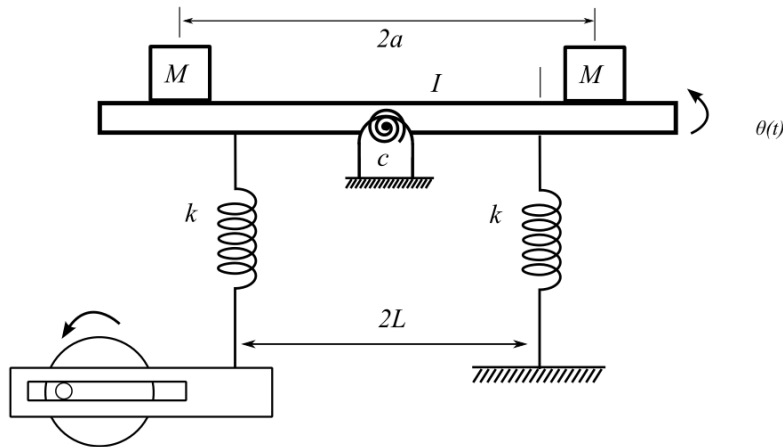

Figure 8. Modeling of the system for forced vibrations

To choose the motor, we first estimated the natural frequency of the system under free vibrations as

$$\omega = \frac{1}{2\pi} \sqrt{\frac{2kL^2}{I + 2Ma^2}} = 4.23 \text{ Hz}$$

where  $k = 0.31 \text{ lb/in}$ ,  $L = 12 \text{ in}$ ,  $a = 0 \text{ in}$ . This means that to demonstrate various rotational speeds for the base motion, the motor should be able to rotate at  $0 \sim 8 \text{ Hz}$ . To meet this requirement and obtain enough motor torque, we chose the motor shown in Fig. 9.



Max Speed RPM	1,500
Power hp	0.44
Torque	3.75 in lbs
Current Load	27 A

Figure 9. Ampflow motor, model # G43-500

To control the motor speed, we used the PWM and power supply with the motor as shown in Fig. 10.



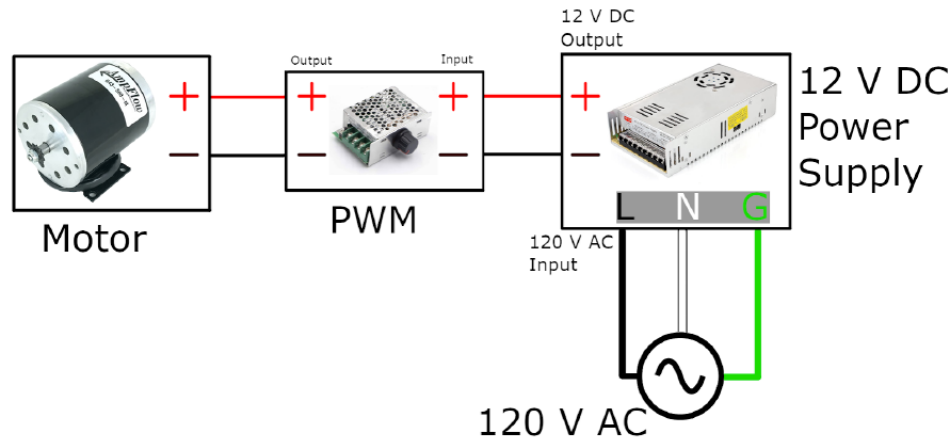

Figure 10. Wiring Diagram for Motor with PWM speed control

Even though the motion of the rotating bar will give the vibration motion so students can find the difference in motions depending on the damping conditions, the speed of vibration may be an issue. The natural frequency of the vibration system is estimated to be around 5 Hz. To test the forced vibration, we need to apply even higher excitation frequency. In addition, the damped vibration motion will decay very fast, and it may prevent the students from fully observing the types of motion.

To efficiently measure and record the motion data, an encoder shown in Fig. 11 was attached to the shaft of the rotating bar. We used Matlab and Arduino to read the rotation angle from the encoder.



Figure 11. Rotary encoder on the shaft

#### IV. Use of the apparatus in vibrations class

##### 1. Demonstration and analysis of free vibrations.

In the classroom, the three types of free vibration motion were demonstrated. Figure 12 shows the angle of the rotating bar as a function of time. They show distinct behaviors for three damping conditions, under-damping, over-damping, and critical damping. By rotating the knob on the rotational damper, the damping is adjusted to achieve these three conditions.

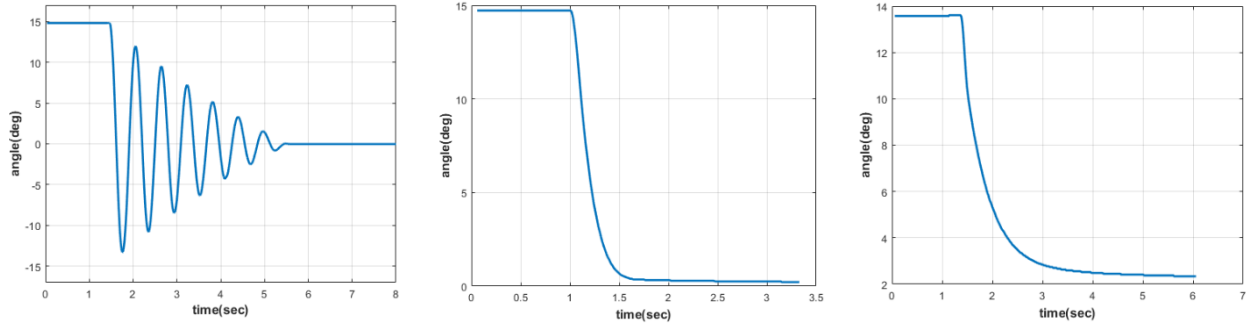

Figure 12. The rotational angle response of under-damping (left), critical damping (middle), and over-damping (right)

The analysis for the underdamped vibration can also be demonstrated. The logarithmic decrement is defined as

$$\delta = \ln \frac{x_{max,1}}{x_{max,2}}$$

where  $x_{max,1}$  and  $x_{max,2}$  are two adjacent local maxima in the under-damped vibration. Using the logarithmic decrement, we can estimate the system's damping ratio as

$$\zeta = \frac{\delta}{\sqrt{4\pi^2 + \delta^2}}$$

With the measurement  $x_{max,1} = 11.99$  and  $x_{max,2} = 9.504$  from Fig. 12, the damping ratio is estimated as  $\zeta = 0.037$ .

*2. Demonstration of forced vibrations.*

In the class, a forced vibration experiment was demonstrated. The resulting motion is plotted as shown in Figures 13.

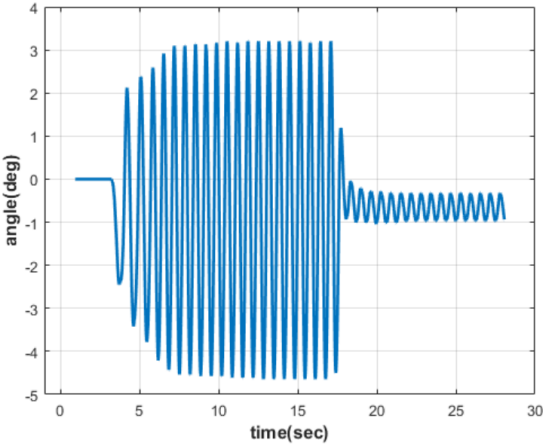

Figure 13. Forced vibration

In this experiment, an excitation vibration at 1.4 Hz was applied from a DC motor through a Scotch-yoke mechanism. Low damping is initially used. At 3 sec, the vibration is applied. Until 7 sec, the system shows transient response. After that, the steady state response continues until

17 sec. At 17 sec, the damping is adjusted to apply higher damping constant. From 17 sec to 20 sec, the second transient response is observed, and then the system reaches another steady state. In this experiment, the students observe that the vibration system shows transient response and steady state, and that the increased damping suppresses the steady state amplitude.

In the class, the effect of damping on the steady state amplitude is theoretically discussed along with the above direct observation. The dynamics equation for the forced vibration model of Fig. 8 can be written as

$$(I + 2Ma^2)\ddot{\theta} + c\dot{\theta} + 2kL^2\theta = kLY \sin \omega t$$

The amplitude of the steady-state solution is derived as

$$\theta = \frac{kLY}{\sqrt{((2kL^2) - (I + 2Ma^2)\omega^2) + c^2\omega^2}}$$

Increased damping  $c$  leads to lower amplitude of the steady-state solution.

## V. Student evaluation of the apparatus

The educational apparatus developed in this work was used in the author's vibration class for juniors and seniors in fall 2021 and fall 2022.

In fall 2022, the instructor created a short anonymous survey for the students in the vibration class. The following questions were asked, and 25 students out of 60 participated.

*Q1 - The vibration apparatus shown in the class was helpful for my understanding of course contents.*

*Q2 - How can the vibration apparatus be improved for better learning experience?*

*Q3 - Any comments about the vibration apparatus.*

For Q1, 20 students strongly agreed, and 5 students somewhat agreed. No students answered neutral, somewhat disagree, or strongly disagree. This result confirmed that the developed device helped the students get more familiar with the vibration phenomena.

For Q2 and Q3, A student suggested that the apparatus can be used in the earlier time of the semester. The device was demonstrated in the classroom after the related contents were covered. For the future class, it will be planned that the apparatus is demonstrated before and after the detailed theory is covered.

Another student suggested that the device can be more closely observed with longer time. Some students gave the idea that students can learn more by operating the device themselves.

## VI. Conclusion and discussion

This work started from the question "how can we improve learning experience for students in mechanical vibration class?" We hypothesized that an educational apparatus could help students by demonstrating physical vibration motions under various conditions. Realizing that students are struggling to obtain intuitive understanding of vibration phenomena, we initiated a capstone

design project for senior students where an educational apparatus is designed and built for the vibration class. The course instructor and/or the TA could build the device, but we decided to use the well-established capstone design program hoping that this project provides educational benefits not only the students in the vibration class, but also the design team.

Using the developed apparatus, free and forced vibrations were demonstrated with the motion data measured in the encoder. The student survey confirmed that the device demo helped the students better understand the physical vibration phenomena. The list of materials and components are provided in Appendix.

## Acknowledgements

This educational research is sponsored by the Department of Mechanical Engineering at The University of Texas at Dallas. The author thanks the students (Paul Williams, Christian Schafer, Jorge Carrasco, Rodolfo Butanda, Ryan Tottori, Carter Smith) who carried out this senior design project. The mechanist Andrew Bittner helped in finalizing the mechanical assembly. Dr. Robert Hart and Dr. Stephan Thamban helped the author initiate the senior design project for this research.

## Appendix

### List of materials and components

Item Description	Vendor Info	Model Number	Qty
Spring Key Rings	Home Depot	8236649901	1
3/8" Jam Nut	Home Depot	887480115512	1
1/4" Washers	Home Depot	88748003413	1
1/4" Mach Screws	Home Depot	887480041415	2
#6-32 x 1/2" Screws	Home Depot	887480030211	2
Damper	Efdyn	KD-A1-DD	1
Motor	Ampflow	G43-500	1
Breadboard Wire Bundle	Amazon	B07ZQL2Q81	1
Encoder	Amazon	B01EWLCM1C	1
Arduino	Amazon	A000066	1
Power Supply	Amazon	AL12V30AT	1
PWM	Amazon	RR-MJLK-FBDG	1
Cart	Amazon	SC4025-3BLK	1
Extension Cord	Amazon	31536	1
USB A - USB-B	Amazon	B0000511K0	1
Pico 10AWG Wire	Amazon	81106PT	1
48" x 48" 12-gauge Steel	Metalsdepot	C1008 Cold Roll	1
0.5" x 6" x 10" Aluminum Plate	SteelNow	6061 Bare Plate	1
Ball bearing	McMaster	5913K61	2
D Profile Shaft	McMaster	8632T7	1
Spring Hook	McMaster	9491T14	2
Holder Toggle Clamp	McMaster	5093A55	2
Damper Shaft Coupler	McMaster	61005K522	1
Flanged Shaft Collar	McMaster	9604T14	1
Threaded Foot	McMaster	23015T64	1

Item Description	Vendor Info	Model Number	Qty
Springs	McMaster	9654K457	1
Encoder Shaft Coupler	McMaster	3084K31	1
#8-32 Threaded Rod	McMaster	90322A625	1
M3 Encoder Bolts	McMaster	91290A111	1
Wing Bolts	Home Depot	887480337785	2
#8 Washers	Home Depot	887480024616	2
8020-1x2-1x2-cornerbracket	Tnutz	CB-010-E	3
8020-3Hole-corner bracket	Tnutz	CB-010-C	3
8020-2x1-flatbracket	Tnutz	JP-010-A	4
8020-3x1-flatbracket	Tnutz	JP-010-C	2
8020-2X3-flatbracket	Tnutz	JP-010-F	1
8020-FootBasePlate	8020.net	2129	8
T-nut and Bolt Combo	Tnutz	COMBO-010-A	305
80/20 1x1 36 Inch	8020.net	1010	4
80/20 1x1 48 Inch	8020.net	1010	2
80/20 1x2 36 Inch	8020.net	1020	5
80/20 1x3 36 Inch	8020.net	1030	2
6 inch 45 Degree Support	8020.net	2565	1
12 inch 45 Degree Support	8020.net	2570	2
ShortLinearBearing	8020.net	6415	1
8020_2x1-2x1-CornerBracket	Tnutz	CB-010-D	5
8020-1x1-1x1-cornerbracket	Tnutz	CB-010-B	16
8020-2x3-2x3-cornerbracket	Tnutz	CB-010-J	4
8020-LivingHinge	8020.net	4180	1
8020-2x2-2x2-cornercracket	Tnutz	CB-010-H	18

## References

- [1] B. Balachandran and E. B. Magrab, *Vibrations*. Cambridge University Press, 2018.
- [2] Y. Liu, "Design of instructional tools to facilitate understanding of fluid viscous dampers in a vibration and controls class and course assessment," *2020 ASEE Virtual Annual Conference Content Access*, 2020.
- [3] C. C. McDaniel and G. C. Archer, "Full-scale Mechanical Vibrations Laboratory," *In 2013 ASEE Annual Conference & Exposition*, pp. 23-628. 2013.
- [4] A. Danesh-Yazdi, Y. Wu, and O. Onipede, "Interactive Simulation Modules (ISMs) in Vibrations," *2019 ASEE Annual Conference & Exposition*, 2019.
- [5] T. M. Ericson, "Lessons for Effective Use of MATLAB and Simulink to Explore Advanced Topics: Application in a Vibrations Course," *2021 ASEE Virtual Annual Conference Content Access*, 2021.
- [6] A. Rezaei and A. Davari, "Teaching vibration and control courses using animation, simulation, and experimentation," *In 2005 ASEE Annual Conference & Exposition*, 2005.
- [7] G. G. Ma and X. Le, "Utilize Project to Help Students Learning in Mechanical Vibration Course," *In 2019 ASEE Annual Conference & Exposition*, 2019.
- [8] S. Zhang, "Vibration Analysis Projects of Lumped-Parameter and Distributed-Parameter Systems," *In 2022 ASEE Annual Conference & Exposition*. 2022.