

Board 85: Using Telecommunication Instructional Modeling System (TIMS) in Electrical and Computer Engineering Courses

Dr. Jiahui Song, Wentworth Institute of Technology

Jiahui Song received her B.S. in Automation and M.S. in Pattern Recognition & Intelligent Systems from Southeast University. She received her Ph.D. in Electrical and Computer Engineering from Old Dominion University. She is currently a Professor

Dr. Douglas Eric Dow, Wentworth Institute of Technology

Professor at Wentworth Institute of Technology in the Department of Electrical and Computer Engineering (started 2008). Education B.A. in Liberal Arts Engineering from Wheaton College (Wheaton, IL); B.S. in Electrical Engineering from Texas A&M University (College Station, TX); M.S. in Computer Science from University of Colorado (Colorado Springs, CO); M.S. and Ph.D. in Biomedical Engineering from University of Michigan (Ann Arbor, MI). Worked in industry for about 9 years at Ampex Corporation (video systems manufacturing) in Colorado Springs CO, Panasonic (central research lab) in Osaka, Japan, and National University of Singapore (center for image enhanced medicine) in Singapore. Post Doc or Sabbatical research was done at Tohoku University (biology information systems) in Sendai, Japan, Mayo Clinic (respiration research lab) in Rochester MN, and Kansai University (knowledge information systems) in Osaka, Japan. Core focus involves embedded electronic systems for applications in medical rehabilitation, health monitoring, physical therapy and assistive technologies. This involves development of hardware and software systems with sensors, embedded control and mechanical actuators. Applications include respiration monitoring, sleep apnea, rehabilitation of impaired muscle for recovery of motor function, health monitoring for elderly to extend independent living, and diabetes management. These systems utilize internet of things (IoT) for remote communication between patient, medical staff, care-givers and instrumentation.

Dr. Wayne Bynoe, Wentworth Institute of Technology

I am a professor in the School of Engineering at Wentworth Institute of Technology. My area of specialization is Computer Networks. I worked for decades as a Technical Staff member at MIT Lincoln Laboratory in the areas of computer network modeling and simulation and high performance processor design for signal processing applications.

Using Telecommunication Instructional Modelling System (TIMS) in Electrical Engineering Courses

Abstract:

Conventional courses in signals and systems and communications systems use lecture and readings to explain the theory and assign paper-based problem sets of theory and math, possibly supplemented with simulation labs, such as using Matlab and Multisim. Software based simulation studies are a useful learning tool. However, computer simulations cannot model all aspects of the behavior of actual systems.

An analog hardware based system is available called Telecommunication Instructional Modelling System (TIMS). TIMS is an advanced system for telecommunications training. TIMS is a rack and module system, in which hardware modules perform basic communication or signal processing functions on actual analog signals in hardware. For example, there are adders, multipliers, filters, samplers, and signal generators. TIMS provides students with a way of prototyping signal processing and communication systems in the laboratory that helps understanding.

TIMS provides a more "real world" and hands-on experience in courses that involve signals and communication compared with only software simulations for students. A series of laboratory exercises for a signals and systems course was developed to help students understand and visualize the complex mathematical concepts and gain a better appreciation for how the concepts are useful in real-world situations: Fourier series analyzer, spectrum analysis of signals, and sampling and aliasing. TIMS labs were also developed for a communication course to give students more hands-on experience with the theories and concepts of communications, such as amplitude modulation/demodulation, frequency modulation/demodulation, ASK generation/demodulation, BPSK generation/demodulation, FSK generation/demodulation. TIMS units are hardware training systems, with which the students build the circuits at a block diagram level and observe the analog results using oscilloscope.

Evaluations were based on student surveys (course evaluations) and student work (assigned homework, exams and labs) over the last 5-year utilization of the TIMS system. 83% of signals and systems class students "agree" or "strongly agree" that the TIMS laboratory exercises helped them to better learn the course content. 82% "of the students agree" or "strongly agree" that laboratory exercises increased their interest in the subject. 95% of engineering communication systems students "agree" or "strongly agree" that TIMS helped them to better learn the course content. 94% of students "agree" or "strongly agree" that TIMS increased their interest in the subject.

Introduction

At Wentworth Institute of Technology, junior level electrical and computer engineering students with the required prerequisites of multivariable calculus and differential equations take signals and systems to acquire a strong foundation for advanced courses, such as communication systems, digital signal processing and feedback controls. Courses in signals and systems are

based on complex, abstract, theoretical, and mathematical concepts that are hard for many undergraduate engineering students to fully understand^[1-4]. Typical pedagogy involves theory with lectures and readings, mathematical homework, and exercises with computer simulations. Since the concepts are difficult for the students to visualize, most students have no conscious personal experience with these phenomena^[1].

Another course with abstract theoretical and mathematical concepts is engineering communication systems. This is a senior electrical engineering course at our university. The course provides an introduction of the fundamentals of communication systems. Communication systems involve an original message being carried from one location to another, using either analog or digital modulation. The course content is based on complex and mathematical concepts that are hard for many undergraduate engineering students to fully understand. A laboratory component is included in the course. Traditionally, the labs had the students utilize computer simulations of the signals with Matlab and Multisim for amplitude modulation/demodulation, frequency modulation/demodulation, and phase shift keying. PC based simulation studies are a useful learning tool. However, simulations cannot model all aspects of the behavior of actual systems. The learning experience for students may miss the insight and intuition that may have developed if they had direct experience with actual analog electrical communication signals.

Tim Hooper developed the first version of Telecommunication Instructional Modelling System (TIMS) in 1971. TIMS is an analog hardware training system, designed specifically for signal processing and telecommunications courses that requires only an oscilloscope to use the system^[5-7]. TIMS allows students to experiment with real world electrical signals in a way that is doable and understandable for more students compared to utilizing only theory and simulations.

The TIMS system has been reported to have been used in some universities around the world^[5-6, 8]. TIMS allows students to learn about the concepts of the many sub-sections of signals and telecommunications, and gives a more hands-on experience. This paper presents examples and effectiveness of TIMS labs that were developed for and used within junior and senior-level courses, and compares the results with a prior, more traditional course offered by the same instructors.

Design of TIMS Labs

This Signals and Systems course is a 4-hour lecture, 4-credit course. The following topics are introduced to students: signal operations, classifications of signals and systems, time-domain analysis of continuous-time systems, Laplace transform, Fourier analysis, sampling, and discrete-time signal analysis. Inspired by an ASEE workshop at University of Rhode Island that focused on combining MATLAB simulation with TIMS^[2], three TIMS labs were developed and used in the course. The three labs include: Fourier series analyzer, spectrum analysis of signals, and sampling. Three of the previously developed and utilized MATLAB based simulation labs were selected, modified and used to supplement the TIMS labs. The topics of the simulation labs include: system linearity, frequency response and Bode plots, and filter design. The students did each lab with two students per group.

The Engineering Communication Systems course is for senior students in electrical engineering. This course is a 3-hour lecture, 2-hour lab, 4-credit course. The following topics are introduced to students: amplitude modulation, angle modulation, probability and random processes, effect of noise on analog communication systems, analog to digital conversion, digital modulation, and digital transmission. Five TIMS labs were added to the course: amplitude modulation/demodulation, frequency modulation/demodulation, ASK generation/demodulation, BPSK generation/demodulation, and FSK generation/demodulation. The students did each lab with 2 students per group. Moreover, three of the previously developed and utilized computer simulation labs were modified and used to supplement the TIMS labs. The topics of the simulation labs include: system property, angle modulation/demodulation, and noise analysis.

With the TIMS systems, the electrical time-based signals are formed and manipulated by patching together TIMS modules. Some modules represent fundamental signal building blocks that are the hardware realizations of signal processing schemes or telecommunications systems.

As an example of the developed TIMS labs, the first TIMS lab in Engineering Communication Systems was amplitude modulation/demodulation. Figure 1(a) shows the block diagram for amplitude modulation, for which Figure 1(b) shows the module connections. A DC component is added to a message sinewave. The resulting signal multiplies a carrier sinewave with a much higher frequency 100kHz to generate the amplitude modulated signal.

For the second half of the lab, the modulated signal needed to be demodulated to recover the message, Figure 2(a) shows the block diagram of the ideal envelope detector, for which Figure 2(b) shows the module connections. The amplitude modulated signal goes through a rectifier followed by a low pass filter to isolate the original message signal.

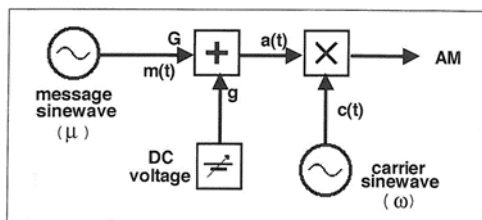

Figure 1(a) Generation of AM. A generated sinewave has a DC offset added. The resulting signal is multiplied by a carrier sinewave.

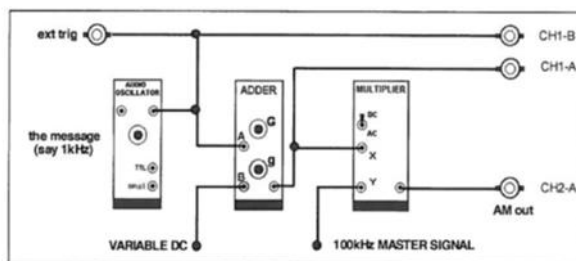

Figure 1(b) Module connections for schematic of Figure 1(a).

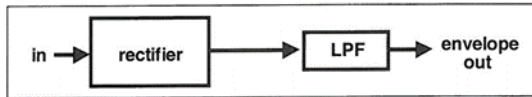

Figure 2(a) Envelope recovery arrangement. An amplitude modulated signal goes through a rectifier followed by a low pass filter to isolate the message signal.

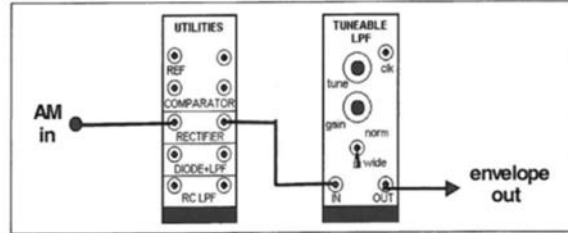

Figure 2(b) Module connections of envelope detector.

An image of the TIMS connected for this lab is shown in Figure 3. The TIMS rack system consisted of the following equipment: (a) EMONA TIMS, (b) Agilent MSO-X 3102A Oscilloscope. Three modules of the TIMS system were utilized for amplitude modulation: Audio Oscillator, Adder, and Multiplier. Utilities, and tunable low pass filter (LPF) were used for amplitude demodulation. Students used TIMS modules to generate amplitude modulated signal with 100 kHz carrier. They varied the amplitude and frequency of the modulating signal, and modulation indices to see the results on oscilloscope in both time and frequency domains. Then the students demodulated the modulated signal and observed it in time and frequency domains. Figure 3 shows an image of the TIMS modules and connections that implement modulation and demodulation.

Figure 4(a) shows the time and frequency domains of the modulated signal, and Figure 4(b) shows the time and frequency domains of the demodulated signal.

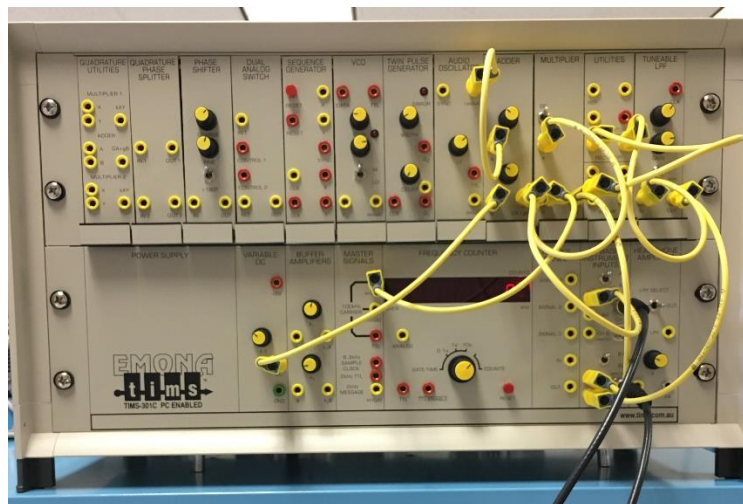

Figure 3 TIMS platform for amplitude modulation and demodulation.

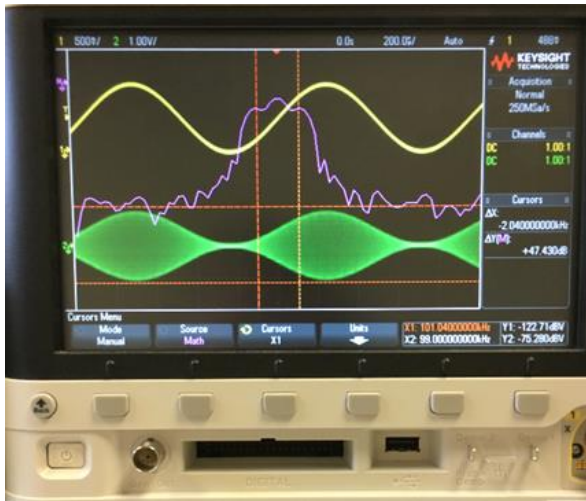

Figure 4(a) Amplitude modulated signal in time and frequency domains. The upper trace in yellow is the message. The lower trace in green is the modulated signal. And the middle trace in purple is the frequency domain representation of the modulated signal.

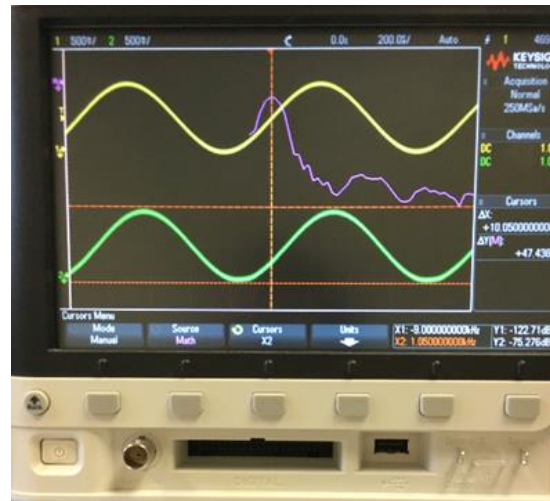

Figure 4(b) Amplitude demodulated signal in time and frequency domains. The upper trace in yellow is the message. The lower trace in green is the demodulated signal. And the middle trace in purple is the frequency domain representation of the demodulated signal.

Another example of the developed TIMS labs, the first digital TIMS lab used in Engineering Communication Systems had the students explore amplitude shift keying (ASK) generation/demodulation. ASK is a modulation process which imparts to a sinusoid two or more discrete amplitude levels. For a binary message sequence there are two levels. The modulated waveform consists of bursts of a sinusoid^[8]. Figure 5(a) shows the block diagram for ASK generation, for which Figure 5(b) shows the module connections.

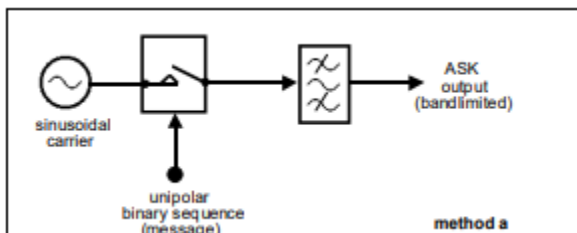

Figure 5(a) ASK generation

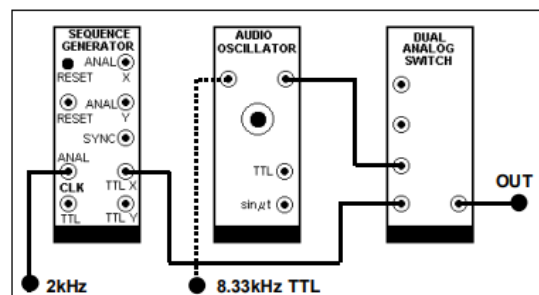

Figure 5(b) Module connections for Figure 5(a)

An image of the TIMS connected for ASK generation is shown in Figure 6(a). The TIMS rack system consisted of three modules: Sequence Generator, Audio Oscillator, and Dual Analog Switch. Utilities, and a tunable low pass filter were used for the ASK demodulation. Figure 6(b) shows the ASK generated signal. The upper trace in yellow is the ASK signal, and the lower trace in green is the original signal. Students used TIMS modules to generate and demodulate ASK signal.

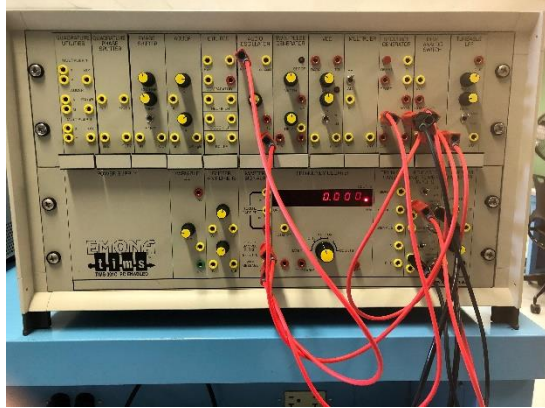

Figure 6(a) TIMS platform for ASK generation. Three modules Sequence Generator, Audio Oscillator, and Dual Analog Switch are used.

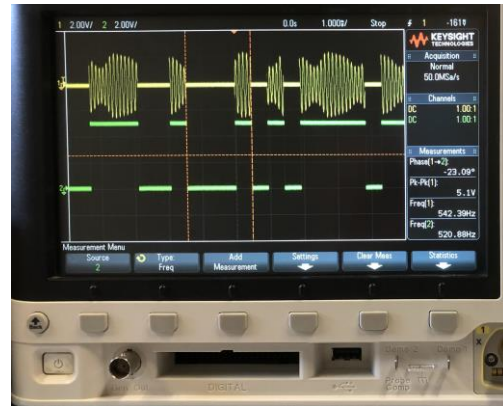

Figure 6(b) Original message and ASK waveform. The upper trace in yellow is the ASK signal. The lower trace in green is the original signal.

An example of a TIMS lab that developed and used in the Signals and Systems course had the students explore sampling and message reconstruction. Figure 7 shows module connections for sampling and reconstruction. Three modules of the TIMS system were utilized for sampling and reconstruction: Twin Pulse Generator, Dual Analog Switch, and Headphone Amplifier. The Twin Pulse Generator produced switching function from a clock signal, and the output of the Dual Analog Switch was the sampled message. The message samples were connected to the input of the 3 kHz LPF in the Headphone Amplifier to recover the original message. Students used TIMS modules to sample and recover the message signal. They adjusted the pulse width to see the results on oscilloscope.

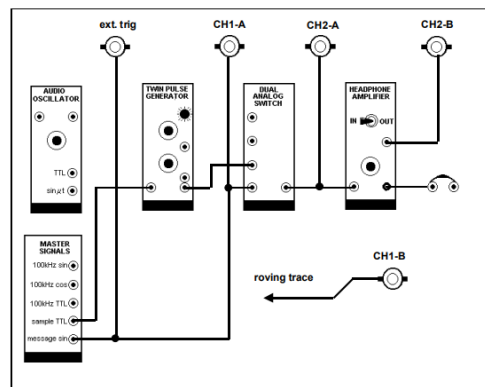

Figure 7 Module connections for sampling and reconstruction.

Results of TIMS Labs

Course assessment of Signals and Systems:

Table 1 provides the students' final grades when the Signals and Systems course was taught by the same instructors either with lectures only or with lectures and the new TIMS labs. While the course was taught with lectures only, homework assignments took 30% of overall grade and exams took 70% of overall grade. There was no lab section for Signals and Systems course, so

all laboratory exercises were done during the lecture time. Laboratory exercises counted as homework assignments, which took 30% of the overall grade. 34 students enrolled in the lectures-only classes and 159 students took the course when TIMS laboratory exercises were assigned during the recent five years. All students in the lecture-lab classes completed all of these laboratory assignments.

Table 1: Students final grade distribution

Final grade	A and A-	B+, B, and B-	C+, C, and C-	D+ and D	F
Lectures only	14.7%	38.2%	20.6%	17.7%	8.8%
New laboratory exercises	18.2%	56.0%	12.6%	7.5%	5.7%

As shown in Table 1, when students studied the course with lectures only, 53% of the students received A/A- and B+/B/B-. In the offering of the course using the new laboratory exercises, the number of students who received A/A- and B+/B/B- jumped to 74%. The number of students who failed the course declined from 8.8% to 5.7%.

A survey was conducted the last week of the semester each year in the past five years to collect feedback to evaluate what the students thought about the new laboratory exercises labs. Based on the survey, 82% of students “agree” or “strongly agree” that the laboratory exercises increased their interest in the subject (Figure 8), 83% of students “agree” or “strongly agree” that the laboratory exercises helped them better to learn course content (Figure 9).

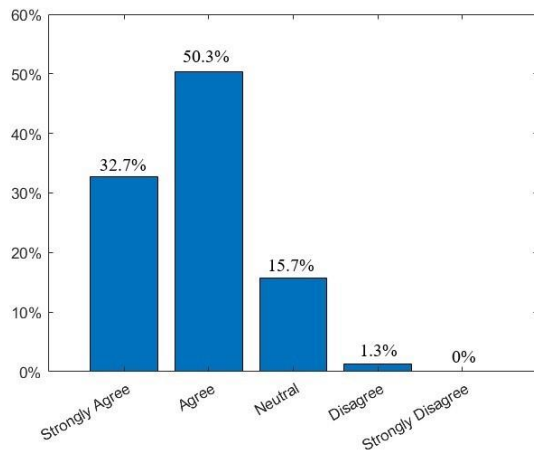
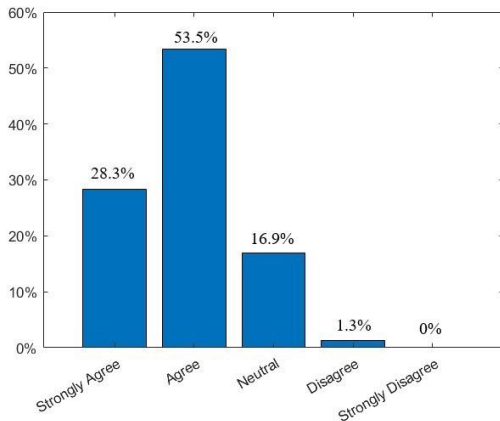

Figure 8: Results for question “The laboratory exercises increased my interest in the subject.” Figure 9: Results for question “The laboratory exercises helped me better to learn course content.”

Course assessment of Engineering Communication Systems:

Table 2 provides the students’ final grades when Engineering Communications Systems were taught either with traditional labs or with TIMS based labs by the same instructor. Labs took 20% of the overall grade while the course was taught with traditional labs or with TIMS based

labs. There were 28 students for traditional labs and 175 students for TIMS labs in the recent five years.

Table 2: Students final grade distribution

Final grade	A and A-	B+, B, and B-	C+, C, and C-	D+ and D	F
Traditional labs	17.9%	42.9%	25.0%	7.1%	7.1%
TIMS labs	24.6%	54.3%	14.3%	3.4%	3.4%

When students studied the course with the traditional labs, 61% of the students received A/A- and B+/B/B-. In the offering of the course using the TIMS labs, the number of students who received A/A- and B+/B/B- jumped to 79%. The number of students who failed the course declined from 7.1% to 3.4%.

A survey was conducted the last week of the semester to collect feedback to evaluate what the students thought about TIMS labs. Based on the survey, 94% of students “agree” or “strongly agree” that TIMS labs increased their interest in the subject (Figure 10), 95% of students “agree” or “strongly agree” that TIMS labs helped them better to learn course content (Figure 11).

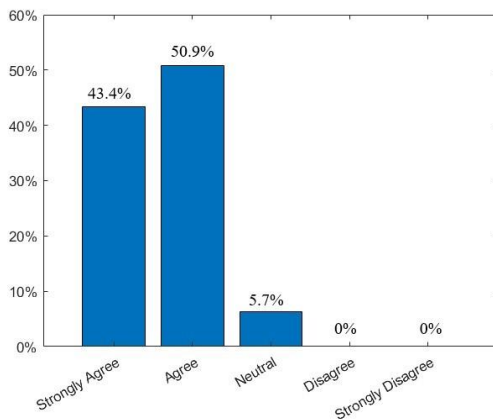

Figure 10: Results for question “TIMS labs increased my interest in the subject.”

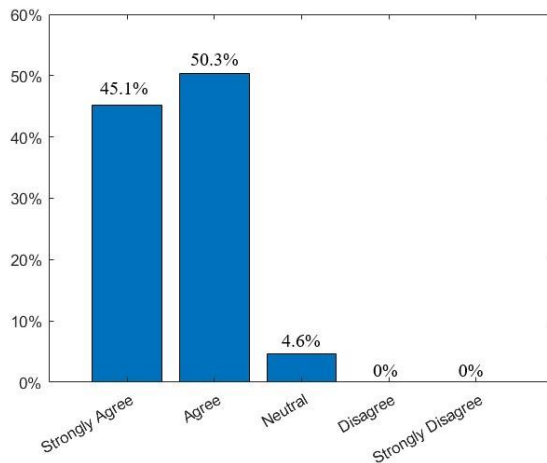

Figure 11: Results for question “TIMS labs helped me better to learn course content.”

Conclusions

Some examples and effectiveness of TIMS labs added to the course content of Signals and Systems, and Engineering Communication Systems for electrical and computer engineering students have been shared in this paper. The TIMS system helps the students develop a more practical understanding of the abstract concepts of signals, modulation/demodulation and their related time and frequency components. TIMS experience for the students not only reinforced the block diagram view of important signal and communication concepts, but also made the students feel that they were engaged in “real-world signals”. Based on our course assessment and

student feedback, TIMS labs seemed to encourage students to be more active participants in the learning process, increase their understanding, and improve their performance. Also, TIMS labs usually involve group work. Engineers are now, more than ever, expected to collaborate and cooperate with their peers^[9]. Future directions for integrating TIMS labs include adding projects that allow students to use “real-world” demodulated audio from local radio stations as the local message signal. Another extension would be to assess whether the students who have benefited from the TIMS experience will continue to be more successful in their future study.

References:

- [1] Simoni, M., Aburdene, M. F., and Fayyaz, F. “Analog-Circuit-Based Activities to Improve Introductory Continuous-Time Signals and Systems Courses”, Proceedings of the 2013 American Society for Engineering Education conference and exposition, 2013.
- [2] Rao, A., Fan, J., Brame, C., and Landman, B. “Improving Conceptual Understanding of Signals and Systems in Undergraduate Engineering Students Using Collaborative in Class Laboratory Exercises”, Proceedings of the 2014 American Society for Engineering Education conference and exposition, 2014. [3] Verdin, B., Borries, R., Nava, P., and Butler, A., “An Experiment to enhance Signals and Systems learning by using technology based teaching strategies”, Proceedings of the 2014 American Society for Engineering Education conference and exposition, 2014.
- [4] Simoni, M., Aburdene, M. F., Fayyaz, F., Labay, V., Wierer, J., and Huang, W., “Improving Learning in Continuous-Time Signals and Systems Courses Through Collaborative Workshops”, Proceedings of the 2013 American Society for Engineering Education conference and exposition, 2015.
- [5] Kinman, P., and Murdock, D., “Communications Laboratory with Commercial Test and Training Instruments, Proceedings of the 2011 Pacific Southwest Regional American Society for Engineering Education Zone IV Conference, California State University, Fresno, CA, 31 March- 2 April 2011.
- [6] Paul B. Crilly and Richard J. Hartnett , “Enhanced Learning – Combining MATLAB Simulation with Telecommunication Instructional Modeling (TIMSTM) in a Senior Level Communication Systems Course”, proceedings of the ASEE NE 2016 conference, 2016.
- [7] Richard J. Hartnett, Paul B. Crilly, "Combining MATLAB® simulation with telecommunications instructional modeling (TIMSTM) in a senior level communications course", 2015 IEEE Frontiers in Education Conference (FIE), vol. 00, no. , pp. 1-4, 2015, doi:10.1109/FIE.2015.7344351.
- [8] Emona Instruments Telecommunications instructional Modeling (TIMS), Camperdown, NSW, Australia, <http://www.emona-tims.com/>
- [9] Bédard, D., Lison, C. , Dalle, D. , Côté, D. , & Boutin, N. Problem-based and Project-based Learning in Engineering and Medicine: Determinants of Students’ Engagement and Persistence. *Interdisciplinary Journal of Problem-Based Learning*, 6(2), 2012.