



Low-Cost Haptics and Visualization to Learn the Atomic Force Microscope Force-Distance Curve

Nisal Ovitigala

I'm an international student from Sri Lanka that graduated MIT with a B.Sc. in Mechanical Engineering. During my time at MIT, I spent a lot of time as an undergraduate researcher in various research groups such as conducting metallurgy research in the Taşan group, robotics research at the d'Arbeloff lab, and engineering education research with the LEAP group. One of my projects with the LEAP group was developing a computer interface to remotely manipulate and view a light microscope so that virtual students enrolled in the Micro/Nano Engineering Lab class can have a hands on experience during the COVID lockdowns. My senior thesis with the LEAP group was to develop a hands on, low-cost and intuitive device for students to learn the core principles of an AFM's functionality and in turn reduce the barrier to entry for the field of nanotechnology. I now work at Formlabs as a Test Engineer that validates quality and functionality of systems in 3D printers

Benita Comeau

Emily Welsh

Ms. Welsh works as an educational technologist in the LEAP Group at MIT. Her work includes the development and running of MOOCs, the development of digital education tools, and researching how digital tools impact learning. Her background is in mechanical engineering with a focus on manufacturing. Prior to joining MIT, she worked at an original equipment manufacturer.

Nicholas Xuanlai Fang

John Liu (Dr.)

Dr. John Liu is the principal investigator of the MIT Learning Engineering and Practice (LEAP) Group, which applies design and systems principles to solving challenges in learning and develops learning experiences to better meet the increasing demand for STEM skills in tomorrow's workforce. He is a Lecturer in MIT's Mechanical Engineering department and Scientist of the MITx Digital Learning Laboratory. Dr. Liu's work includes engineering education, mixed reality and haptic experiences, workforce solutions to address the nation-wide manufacturing skills gap, open-ended assessments for scalable education settings, and instructional design theory for massively open online courses.

Low-Cost Haptics and Visualization to Learn the Atomic Force Microscope Force-Distance Curve

Abstract

Acquiring competency in nanotechnology requires understanding of phenomena that are inaccessible to the everyday macro-world experience of the student. Significant capital requirements for nanoengineering laboratory equipment and small student cohort sizes limit student opportunities for hands-on learning. These factors may present barriers to entry for introductory students to pursue a career in nanotechnology. Haptics and interactive visualization afford students the opportunity to gain intuition through active learning and engaging different senses; however, commercial haptics setups are often prohibitively expensive for the average lab.

We explore the feasibility of teaching non-intuitive nanotechnology concepts by designing, developing, implementing, and assessing a low-cost haptics and visualization activity for the teaching of the force-distance curve concept and its connection to the Atomic Force Microscope (AFM). Forces and length scales relevant to AFM measurements are well below what we experience in our everyday lives, making the study and understanding of this topic difficult for students to intuitively understand. The haptic feedback controller and accompanying computer application enable students to “feel and see” the forces an AFM tip experiences as it approaches the surface of a measured sample. This instructional activity has now been implemented in an undergraduate-level class (“Micro/Nano Engineering Laboratory”) at the Massachusetts Institute of Technology in which mechanical engineering students obtain their first experience with nanotechnology. Students were split into two groups for instruction and assessment; students in Group 1 (N=7) received traditional lab instruction and students in Group 2 (N=4) received the same activity with haptic and visualization as a medium for relaying information.

Post-instruction assessment reveals promising learning outcomes. Group 1 students scored an average of 55% and Group 2 students scored an average of 96%. The software is scalable, and the developed controller costs ~\$150 — as opposed to thousands of dollars for a traditional haptics controller — making the activity feasible for a range of teaching labs. The work presented in this paper suggests that haptics and visualization can serve as useful tools to teach challenging nanotechnology concepts, thereby making the field accessible and attractive to a broader range of students.

1. Introduction

Nanotechnology is a rapidly growing research segment that has applications in a variety of industries including semiconductor, medical, and consumer electronics. Nanotechnology deals with the manipulation of atoms and molecules on scales that are usually smaller than a 100 nm. These nanomaterials can be engineered to have properties that are nearly impossible to recreate with macroscopic materials. Due to the field’s interdisciplinary nature, it employs scientists and engineers from a multitude of educational backgrounds [1].

The US has been known as the leading force in semiconductor technology for the past 50 years and that reputation is coming under challenge due to the high educational barrier of entry for

university students in the field of nanotechnology, as the capital cost of typical research equipment is too high for scale up in the regular classrooms. To counteract this, education in nanotechnology must be prioritized, and student interest in the subject must be fostered from as early as high school [2]. We envision that development of low-cost education systems for students to sense and interact with the nanoworld will enhance physical intuition, deepen learner engagement, enrich classroom dynamics, improve learner retention, and maximize use of learner time in the lab. In the broader context, the proposed project has the potential to make headway in addressing major challenges facing the learning of engineering – the difficulty in conveying engineering concepts due to the limitations of traditional 2D media, the cost of providing physical context and hands-on learning, or the prohibitive danger of certain scenarios.

To address these opportunities, a multimodal teaching approach was implemented into an introductory course on micro/nano engineering where students were taught how to use an Atomic Force Microscope (AFM) accompanied by a hands-on and visualization experience of its working principle. This hands-on learning approach was analyzed through an A/B testing strategy to measure differences in learning outcomes.

2. Background

2.1 The Force-Distance (FD) Curve

The interaction between the AFM tip and surface is easily conceptualized in a macroscale analog, where pushing the cantilever onto a surface will cause a reaction force that makes the cantilever deflect. Introductory students can easily relate to their experience in introductory physics: when a hand pushes against a wall, the wall exerts a reactionary force back onto the hand. This reaction force is the summation of many millions of molecules applying a Coulomb repulsive force due to the like charges in the atomic nucleus of the wall and hand repelling each other. However, this interaction changes as it downscales to nanometer scale.

When an AFM tip approaches a surface, the Coulomb force is only applied by molecules from a small region that exerts a force strong enough to repel the tip. In a similar manner, van der Waals forces are small forces that can be ignored on the macroscale since they act on surfaces within distances of nanometers. As the AFM tip approaches a surface, these attractive forces are strong enough to deflect the tip as well. The summation and strength of these forces measured over the distance between the AFM and surface gives rise to the FD curve. Additionally, phenomena such as surface charging on an insulated material and variations in material properties on a microstructure level can drastically alter the FD curve and makes determining a materials FD curve a multivariable problem.

2.2 Prior Art

There are a number of studies conducted on incorporating haptics into teaching Atomic Force Microscopy. The results from one experiment carried out with 45 students indicate that a “magnet-spring” analogy helped beginners to establish the link between the behavior of a probe and its force–distance curve [3]. Another paper used a simple wooden setup with bottle caps as the sample’s surface to demonstrate the contact and oscillating mode of AFM operation to highschool students which also fostered deep curiosity about nanotechnology in students [4].

Most haptic modules use feedback controllers (common ones include the Phantom Omni and Phantom Premium [5]) whose cost ranges between \$1000-\$4000. Additionally, a skilled professional is required to program and interface these controllers for their required purpose. This poses a financial barrier of entry for institutions with limited resources, particularly for secondary schools where an introduction to nanotechnology could impact early career decisions. This research study aims to develop a low-cost and easy to use hardware and software package to maximize its adoption and recreation.

3. Haptics and Visualization Setup

3.1 Learning Objectives

The learning objectives of the AFM force-distance curve activity are:

1. Explain why material interactions vary between the microscopic and macroscopic scale due to change in scale of forces.
2. Label the different sections of the force-distance curve and the associated forces with that section.
3. Explain the relationship between materials and their force-distance curves. Specifically, what causes attractive/repulsive forces and what properties affect their magnitude.
4. Predict different material types by analyzing their force-distance curve.
5. Recommend how advanced imaging modes use the force-distance curve.
6. Explain how an AFM can be used for material manipulation in addition to imaging.

3.2 Hardware

To first approximation, the forces that act on the AFM tip act primarily along the axis normal to the scanned surface. As such, the hardware developed for this project is a 1 degree of freedom (DOF) linear actuator. The hardware components consist of a backdrivable DC motor [6], belts and pulleys, and 3D printed structures (Figure 1). The motor has an encoder for positional feedback and it is connected to a VNH5019 driver board [7] which sends out current readings to verify the force applied by the motor. The motor transmits power through a belt drive system that moves a handle linearly along a piece of aluminum extrusion. This handle is the gripper which the user moves up and down, and feels force feedback from the motor. The signals from the motor and driver board are sent to an Arduino UNO [8] which is connected to a computer running a MATLAB script that runs the whole system (Figure 2). The build instructions and accompanied software can be found on the MIT LEAP group website [9].

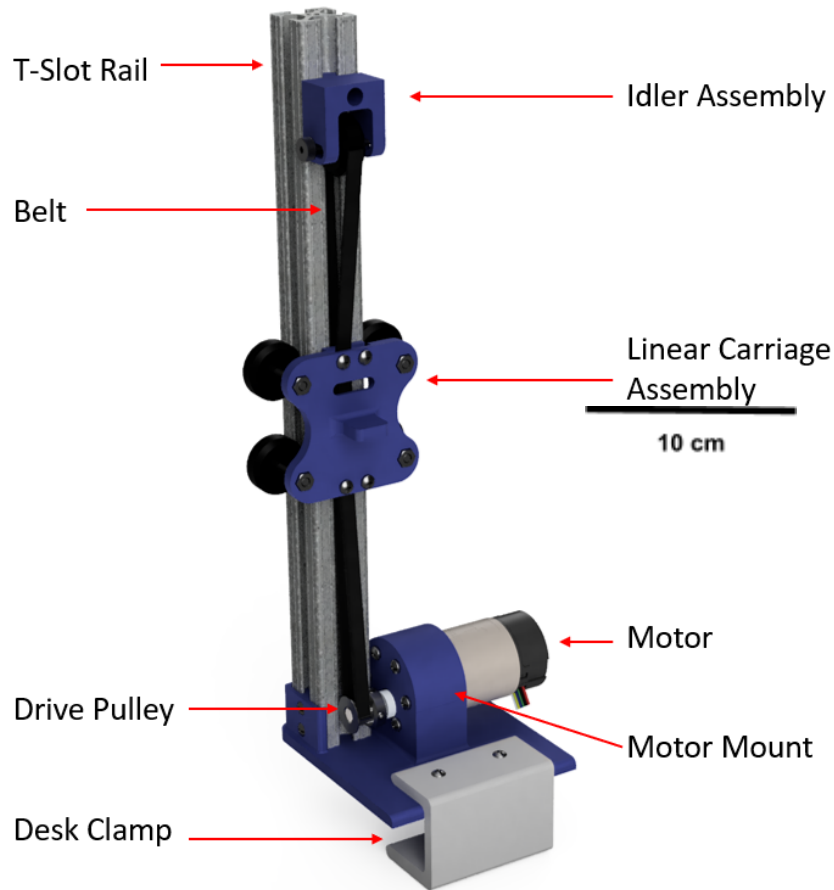

Figure 1: Belt drive haptic module which moves a linear carriage along the vertical axis. The drive pulley and idler assembly tensions the belt on either ends of linear travel. The linear carriage assembly is clamped onto a section of the belt which allows it to move along with the belt.

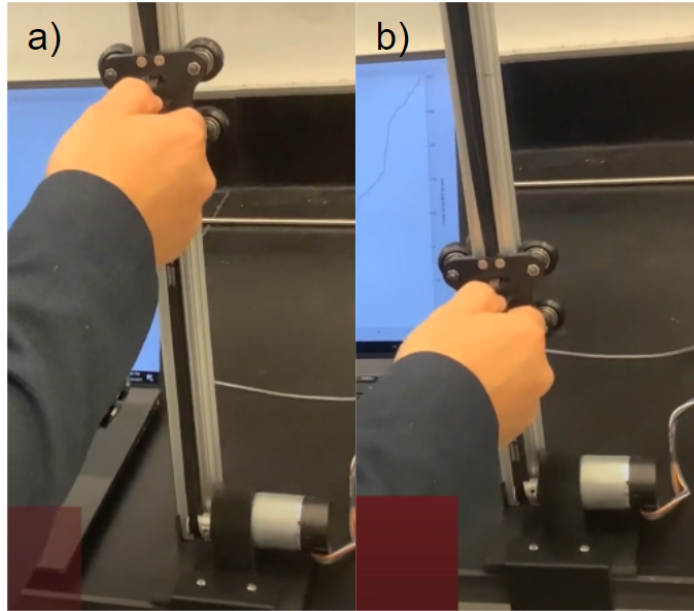

Figure 2: A user interacting with the haptic controller. As the user a) holds the linear carriage assembly and b) pulls the carriage down they feel a pull downwards followed by a strong push upwards.

3.3 Software

The MATLAB script consists of a front-end graphical user interface (GUI) which takes the user's input of material type and preferred feedback strength (Figure 3). It then parses this data and calls a backend function that updates the graph and loads the relevant FD curve onto the hardware.

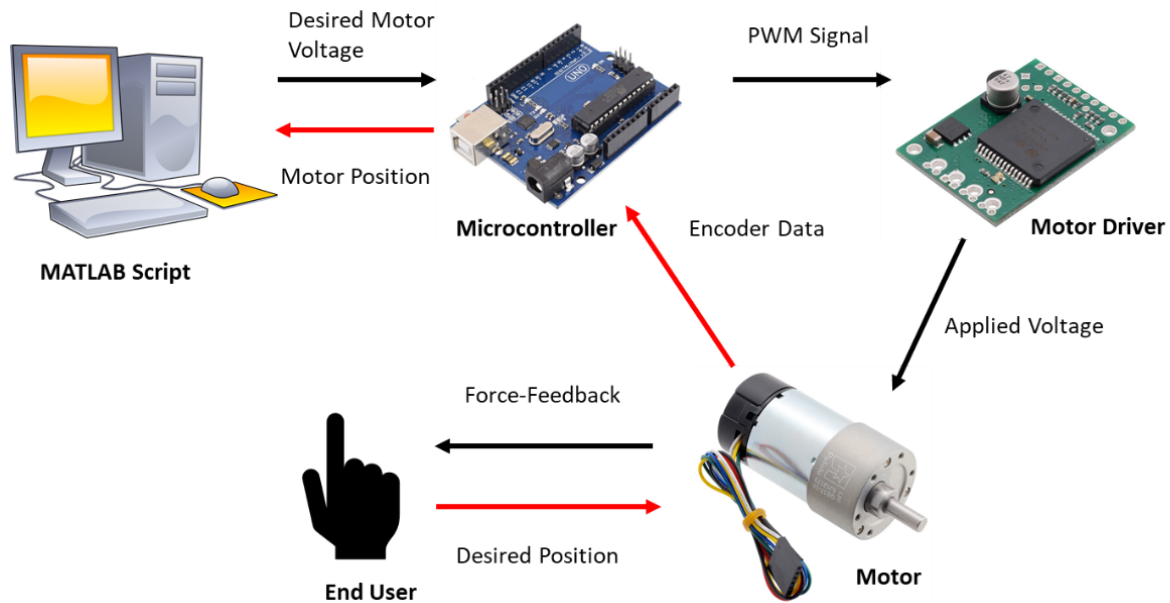

Figure 3: Visualization of interactions between the motor [6], motor driver [7], and microcontroller [8].

The backend script maps the current encoder position onto the loaded FD curve, and signals the motor to provide the required feedback. In addition, the script also updates the current position on the graph so that the users have a visual reference to the forces they are feeling. This process repeats itself until the user exits out of the program (Figure 4).

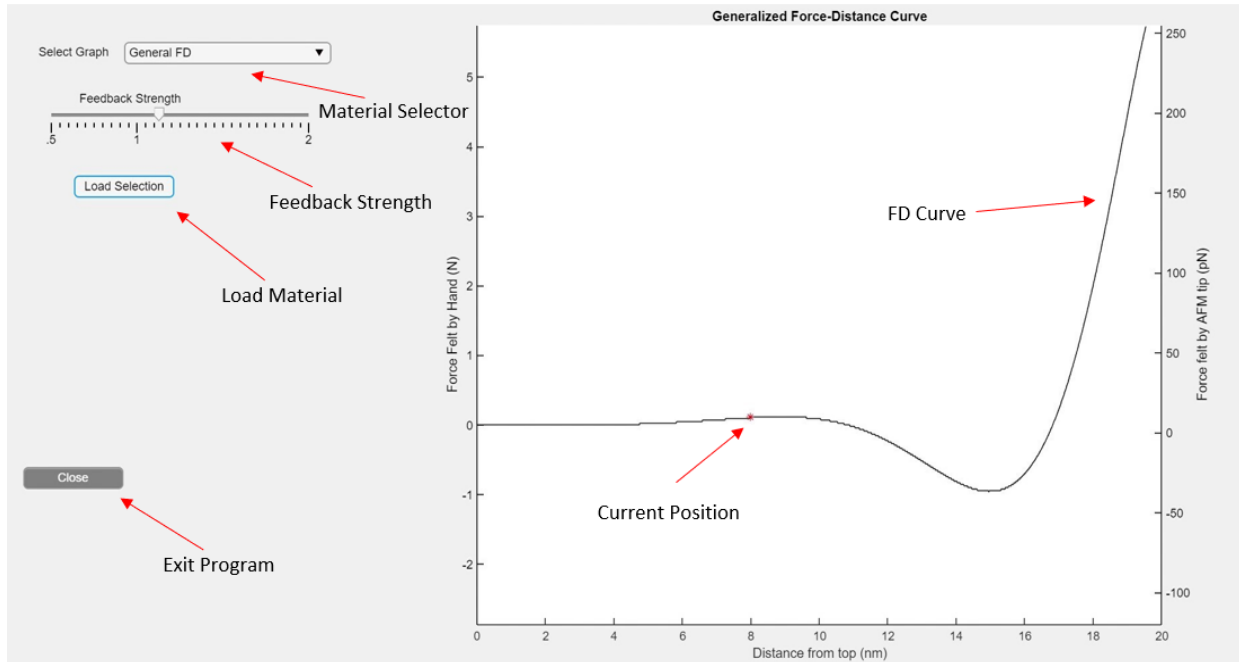

Figure 4: Front-end GUI which the user interacts with. As the user moves the haptic device up and down, the red dot moves along the curve as a visual representation of where the user is on the FD curve.

Empirically obtained datasets of FD curves provided by AFMWorkshop [10] of steel, polymer, and a compliant material (Figure 5) were parsed into the script and fed into the haptic controller, so that users can visualize and feel realistic forces exerted on the AFM tip (Figure 6).

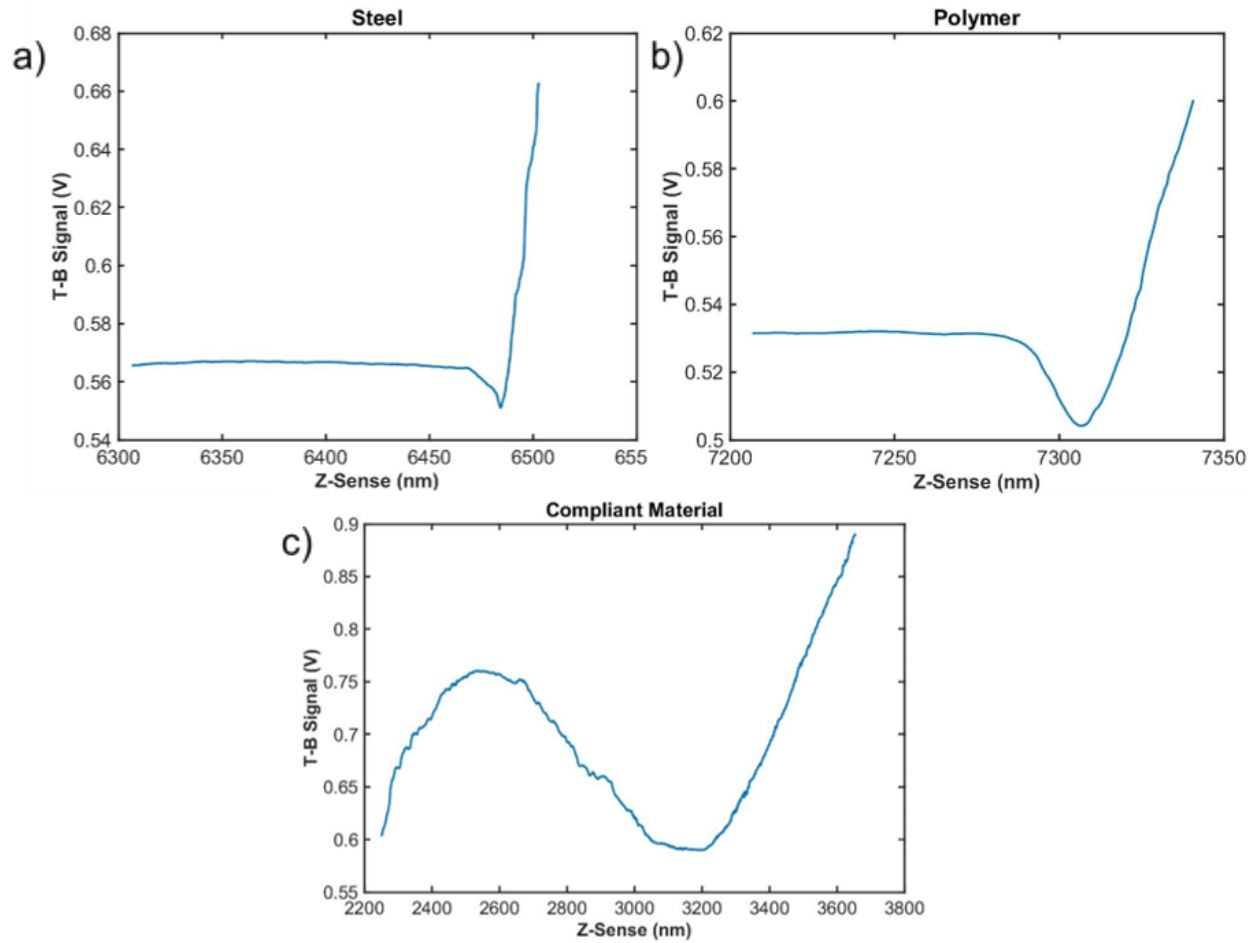

Figure 5: FD curves of three empirically obtained materials that students are required to identify: a) steel, b) polymeric material, and c) a compliant material.

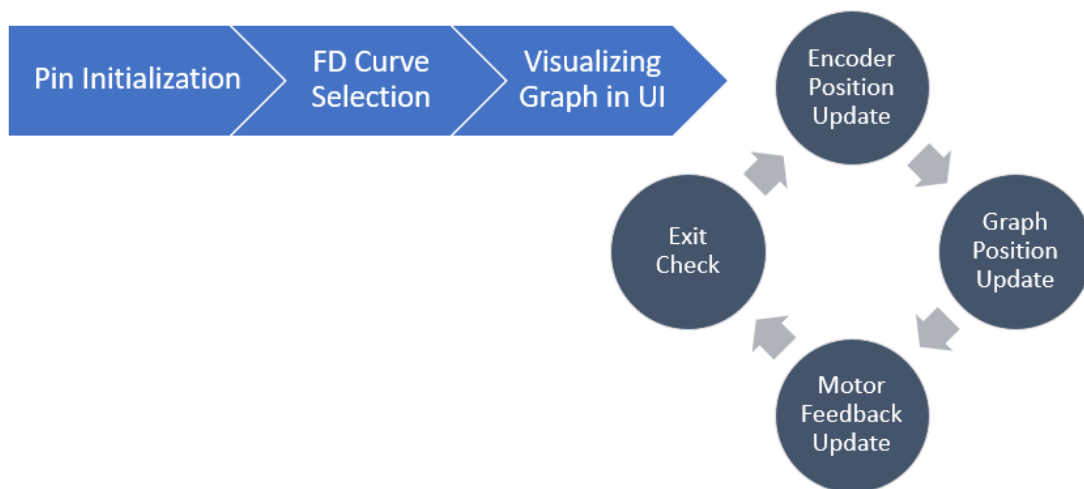

Figure 6: Process diagram of back-end function.

4. Methodology

4.1 Student Testing

To measure the success of this multimodal method of learning, we carried out AB/BA testing with undergraduate mechanical engineering students that have less than 6 months of experience in the field of nanotechnology. Students with similar GPAs were randomly assigned to two groups. Students in Group 1 (N=7) receive instruction in the traditional format (A) and students in Group 2 (N=4) receive the same instruction using a format of haptics and visualization (B) (Appendix A). These groups are then given a written assessment (Assessment 1) to see whether there is a difference in learning between the two groups. The groups then have their roles reversed where Group 1 receives the haptics and visualization format and Group 2 receives the traditional format and are then given a different assessment (Assessment 2) for comparison. A flow chart representation of this process can be seen in Figure 7.

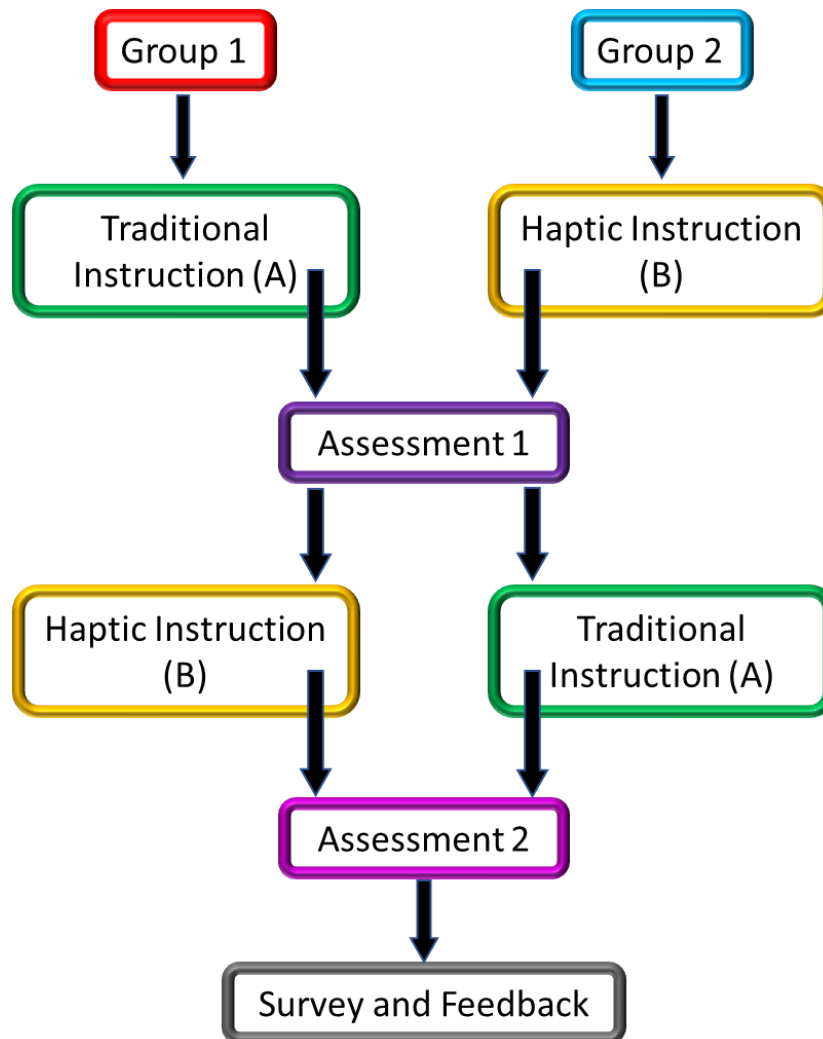

Figure 7: Process of conducting AB/BA testing to compare student understanding of the FD curve through traditional instruction and haptic instruction.

Assessment 1 (Appendix B) tests students on the different areas of the FD curve, and which forces relate to the attractive and repulsive regimes. There is also an extension question on using the AFM to obtain grain geometry for a piece of metal. Assessment 2 (Appendix C) tests students on how a FD curve would change between conductive and non-conductive materials. Assessment 2 also includes an extension question on how an AFM could be used to pick and place nanospheres when a voltage is applied between the tip and the surface. In both the assessments, the extension question is the last in the series of questions so that students are guided into thinking creatively about using the AFM outside of its basic operating mode.

After completing Assessment 2, students are asked to complete a feedback survey (Appendix D) on their experience with the multimodal learning format presented to them. The feedback survey makes statements from which students respond how much they agree with that statement and uses a Likert scale from 1-7 where 1 represents “strongly disagree”, 4 represents “neither agree or disagree”, and 7 represents “strongly agree”. The following questions were asked in the feedback survey.

1. *I liked learning about the AFM using haptics and visualizations.*
2. *I would prefer to learn about the AFM using the haptics and visualization as opposed to traditional text and graphics.*
3. *I learned the necessary material using haptics and visualization.*

Students were also given open-ended prompts asking them how the haptics and visualization setup facilitated or detracted from their learning, and were asked to give feedback on the overall experience.

4.2 Data Analysis

The students' assessment data from each group were compiled together. A single point was given for answering the question correctly and no points were given for wrong answers. These points were then analyzed to obtain the mean and standard deviation of scores between the two groups. The average scores for each question were compared between the two groups, and a paired T-test model was used to compare results from the two groups.

5. Results

At an alpha of .05, there is no statistically significant difference in average scores between the two groups for Assessment 2 ($p = 0.33$). This is what we expect; Assessment 2 (Figure 9) is administered after both groups have received both traditional and multimodal instruction. In Assessment 1 (Figure 8) however, Group 2 students have a higher average score than Group 1 students. This difference is statistically different ($p = 0.0051$), indicating that haptics and visualization instructional format led to a better understanding of the material. The data may also suggest that the order of introducing students to the multimodal instruction and then to regular instruction yields higher assessment scores, but because the difference is not statistically significant, this hypothesis needs further testing. Tabulation of this analysis can be found in Table 1.

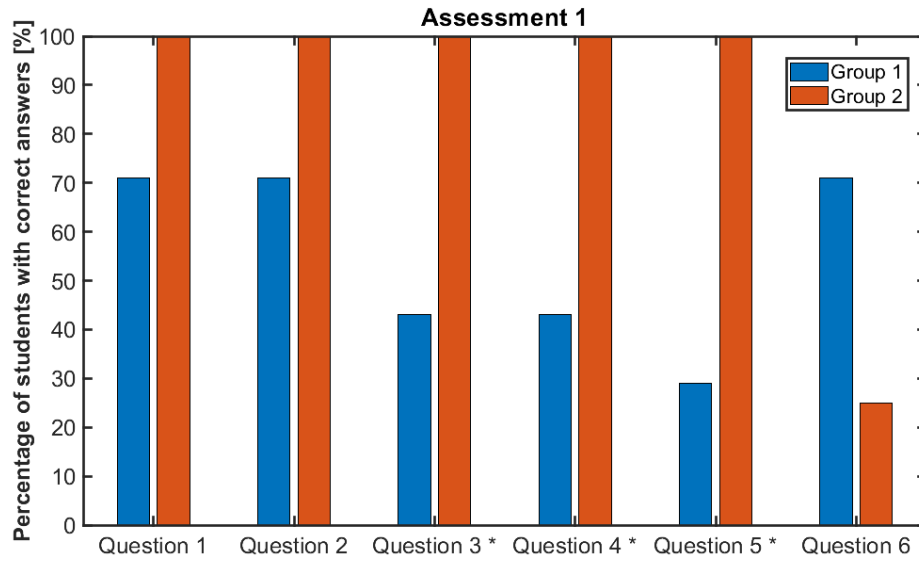

Figure 8: Performance on Assessment 1 by Group 1 (blue) and Group 2 (orange).

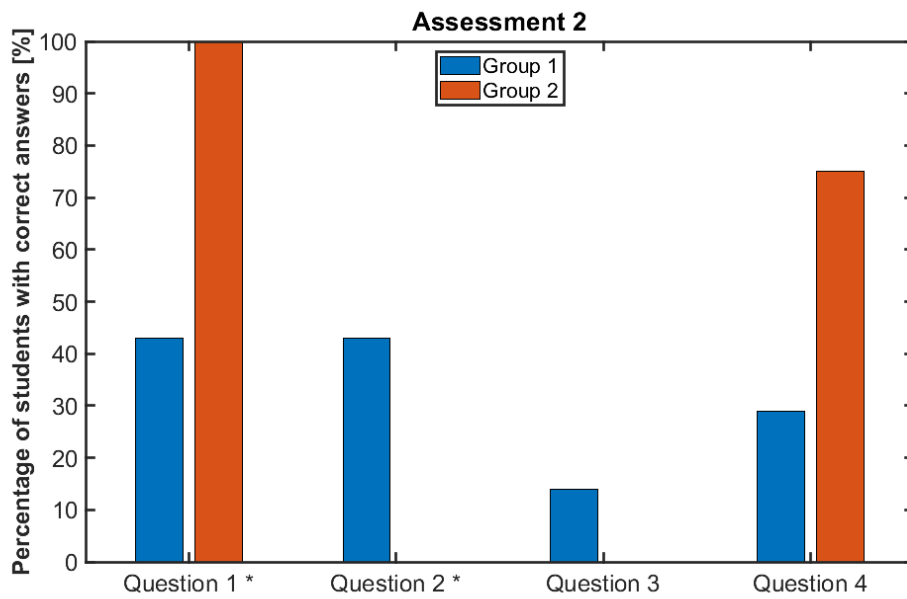

Figure 9: Correct answers to Assessment 2 from Group 1 (blue) and Group 2 (orange).

	Assessment 1 Average	Assessment 1 Standard Deviation	Assessment 1 T-Test	Assessment 2 Average	Assessment 2 Standard Deviation	Assessment 2 T-test
Group 1 (lab - haptics)	55%	17%	0.0051	32%	12%	0.33
Group 2 (haptics - lab)	96%	9%		44%	45%	

Table 1: Summary of student assessment results.

Survey response data from Table 2 suggest that students enjoyed a more hands-on learning approach with respect to the AFM in comparison to lecture style learning with higher-than-average score of 5.6. Students have also shown strong interest in the expansion of multimodal learning methods to the overall learning of the AFM with an average score of 5.9. Lastly, students perceived they were able to learn the necessary material in the AFM lab through multimodal instruction with an average score of 5.1. Students gave comments such as “It gave me an intuition for what the tip senses as it approaches a surface” and “It gave me a much more physical understanding of the process.” Overall, the data and comments suggest that this module did not negatively impact student learning, and instead enhanced the learning experience.

	Average Response	Standard Deviation
Liked learning with haptics	5.6	0.78
Prefer learning with haptics	5.1	1.0
Learned the required material	5.9	1.1

Table 2: Summary of student responses from survey.

When asked the question of “How did using haptics and visualization you received facilitate or detract from your learning?” students gave positive responses stating an increase in intuition and physical understanding of what the AFM tip felt and how the AFM operated overall. One learner said “It gave me a more intuitive sense of what the AFM was experiencing, which made it easier to understand how it functioned.” (See Appendix E for all student responses).

6. Conclusion and Future Work

This study aimed to test the effectiveness of multimodal learning of the AFM’s working principle using haptics and visualization. Based on the student assessments and survey feedback received, the data suggests that there is an increase in student understanding and interest in this method of teaching. More testing is required in a larger classroom setting to further validate these results since the sample size in this experiment was 11 students.

This study also shows promising potential in the larger picture of nanotechnology education. The study used a custom controller which was built for around \$150 and gave students a useful experience. Low-cost setups like these could allow institutions and learning centers to effectively teach nanotechnology without requiring expensive equipment, which can increase accessibility

to nanotechnology. It can also introduce these concepts to students in low-income areas, to foster interest in nanotechnology at a younger age.

The experimental apparatus was designed to introduce undergraduate students to the AFM and its primary working principle, the FD curve. The setup can also be augmented for more advanced instruction. The AFM used for this study, TT AFM [11] by AFMWorkshop, can be interfaced with the haptic controller to control and receive feedback signals from the AFM tip so that FD curves can be felt in real time with user made materials. With relevant hardware upgrades and further software modifications, a variety of AFM scanning modes and multiple motion axes can be felt and controlled by the user to further their educational understanding of AFM's.

This type of low-cost apparatus can be reproduced for a variety of other microscopes to feel and manipulate nanomaterials. For example, the haptic feedback interface could be modified to have 2-DOF and developed to interface with a Scanning Tunneling Microscope to allow users to manipulate nanospheres on a surface. These types of low-cost setups can also be used by educators to incorporate interactive nanotechnological studies for high-school students and financially burdened institutions to lower the barrier to entry of learning nanotechnology and foster greater interest in the field.

7. Acknowledgements

The authors thank AFMWorkshop for their support in providing integration methods to interface between the haptic controller and the AFM, and the empirical Force Distance curves used in the simulations. Professor Jeehwan Kim and Professor Sangook Kim supported piloting these new learning methods in Micro/Nano Laboratory (2.674) and their feedback on the haptic experience. This research was supported by the MIT Alumni Class Fund and the MIT Undergraduate Research Opportunity Program.

8. References

- [1] J. A. Jackman *et al.*, "Nanotechnology Education for the Global World: Training the Leaders of Tomorrow," *ACS Nano*, vol. 10, no. 6, pp. 5595–5599, Jun. 2016, DOI: 10.1021/acsnano.6b03872.<https://mediatum.ub.tum.de/node?id=603020>
- [2] J. del Alamo, "Education and workforce development | Reasserting U.S. Leadership in Microelectronics." Massachusetts Institute of Technology, Sep. 2021. [Online]. Available: <https://usmicroelectronics.mit.edu/education-and-workforce-development/>
- [3] G. Millet, A. Lécuyer, J.-M. Burkhardt, S. Haliyo, and S. Régner, "Haptics and graphic analogies for the understanding of atomic force microscopy," *Int. J. Hum.-Comput. Stud.*, vol. 71, no. 5, pp. 608–626, May 2013, doi: 10.1016/j.ijhcs.2012.12.005.
- [4] G. Planinšič and J. Kovač, "Nano goes to school: a teaching model of the atomic force microscope," *Phys. Educ.*, vol. 43, no. 1, pp. 37–45, Jan. 2008, doi: 10.1088/0031-9120/43/01/002.
- [5] "Phantom Premium 6DOF - EST, Engineering Systems Technologies GmbH & Co. KG." <https://est-kl.com/manufacturer/geomagic/phantom-premium-6dof.html> (accessed May 06, 2021).

- [6] “Pololu - 37D Metal Gearmotors.”
<https://www.pololu.com/category/116/37d-metal-garmotors> (accessed May 06, 2021).
- [7] “Pololu - VNH5019 Motor Driver Carrier.” <https://www.pololu.com/product/1451>
(accessed May 06, 2021).
- [8] “UNO R3 | Arduino Documentation.” <https://docs.arduino.cc/hardware/uno-rev3> (accessed
Jan. 27, 2022).
- [9] “EXPERIENCES | MIT LEAP Group.” <https://leapgroup.mit.edu/experiences/> (accessed
Apr. 10, 2022).
- [10] “AFM Atomic Force Microscopy Workshop - Atomic Force Microscopes - Home.”
<https://www.afmworkshop.com/> (accessed Feb. 02, 2022).
- [11] “Table-Top Atomic Force Microscopes for High-Resolution Sample Scanning.”
<https://www.afmworkshop.com/afm-products/atomic-force-microscopes/tt-2-afm> (accessed
May 08, 2021).
- [12] B. Donner, “Simulation of quantum corrals,” Technische Universität München, 2004.
Accessed: Apr. 10, 2022. [Online]. Available: <https://mediatum.ub.tum.de/node?id=603020>

9. Appendices

Appendix A: Haptics Instruction

You are taking up the role of a materials specialist. A coworker comes to you saying that they performed tests on two different materials to obtain their force distance curve for further material analysis. Due to a software bug, they were unable to label the two graphs and they are having trouble identifying the two materials. All they know is that one of the materials was a polymer and the other was steel. You are tasked with identifying the two materials through your vast knowledge of materials that you learnt from this class.

1. Use the haptic controller to feel the two materials. What differences can you notice between them?
2. What do you think causes the change you felt?
3. Identify the two materials.

Your (thankful) coworker comes to you with another force distance curve for a material known as material X. He mentions that it has a very odd graph and wants your input on it.

4. Use the controller to feel the material. What do you notice that is different from regular FD curves?

Material X has a force distance curve that rises and drops before reacting like a regular material.

5. Why do you think the material exhibits this behavior?

*Hint: Imagine your hand is the AFM tip and you are approaching and slowly squeezing a pillow. What sort of response would you get from that?

Appendix B: Assessment 1

The purpose of these questions is to 1) assess your learning experience and understanding of the AFM force distance curve, and 2) examine the learning effectiveness of instruction in this course. In order for this to be an effective analysis, we need you to answer **all** the questions on your own based on your present knowledge; do not consult the internet, peers, etc. for the answers.

Completion of these questions is mandatory for the AFM lab, but your performance on these questions is not graded. Your identity will be anonymized in any data analysis that we perform. Thank you!

Attached below is an experimentally obtained force distance (FD) curve where the X axis represents the Z travel of the AFM tip from its topmost point and the Y axis represents the normalized deflection of the tip on the cantilevered beam.

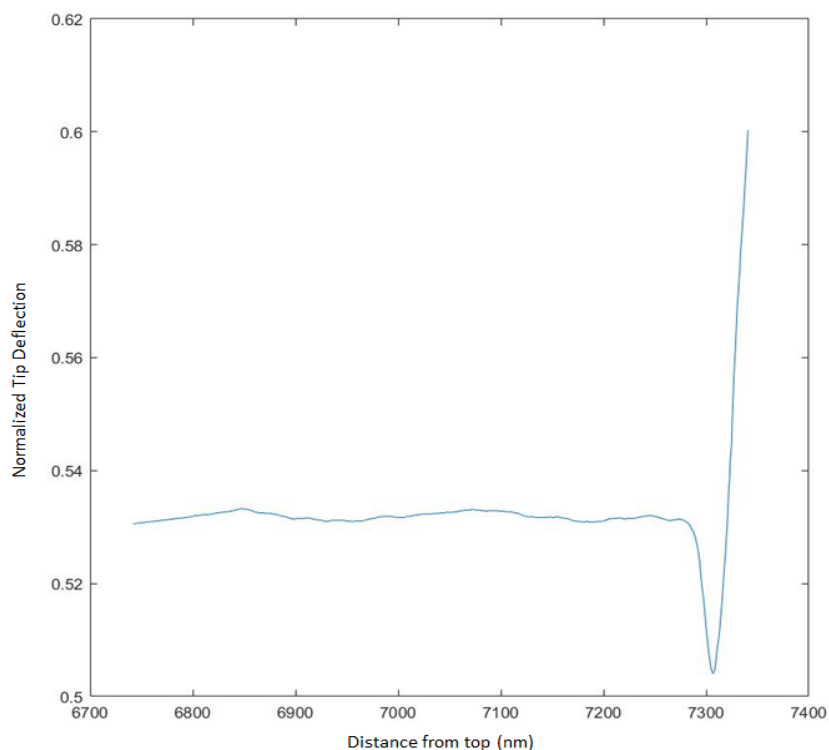

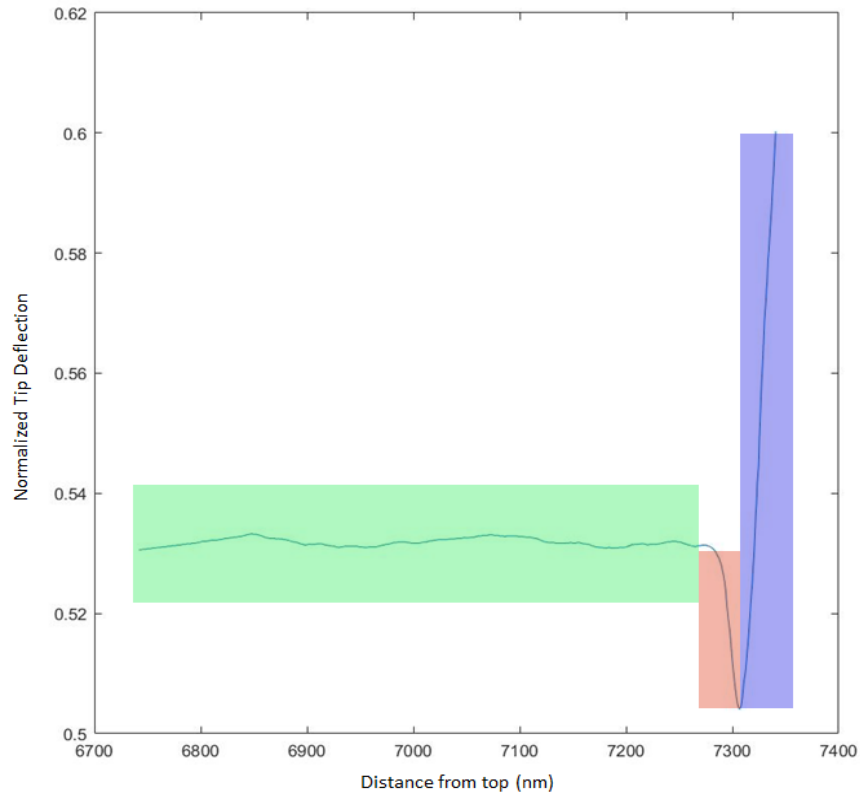

Figure 1: Left plot: FD curve; Right plot: same FD curve with different colored sections

Attached above is an experimentally obtained force distance (FD) curve where the X axis represents the Z travel of the AFM tip from its topmost point and the Y axis represents the normalized deflection of the tip on the cantilevered beam.

1. What do you think happens to the tip in the red section?
 - a. Tip gets pulled towards the surface.
 - b. Tip gets pushed away from the surface.
 - c. Tip gets pushed sideways.

2. What do you think happens to the tip in the blue section?
 - a. Tip gets pulled towards the surface.
 - b. Tip gets pushed away from the surface.
 - c. Tip gets pushed sideways.

3. Identify which atomic force causes the tip response in the green section.
 - a. Coulomb force
 - b. Van der Waals force
 - c. Strong Nuclear force
 - d. Weak Nuclear force
 - e. No interaction

4. Identify which atomic force causes the tip response in the red section.
 - a. Coulomb force
 - b. Van der Waals force
 - c. Strong Nuclear force
 - d. Weak Nuclear force
 - e. No interaction

5. Identify which atomic force causes the tip response in the blue section.
 - a. Coulomb force
 - b. Van der Waals force
 - c. Strong Nuclear force
 - d. Weak Nuclear force
 - e. No interaction

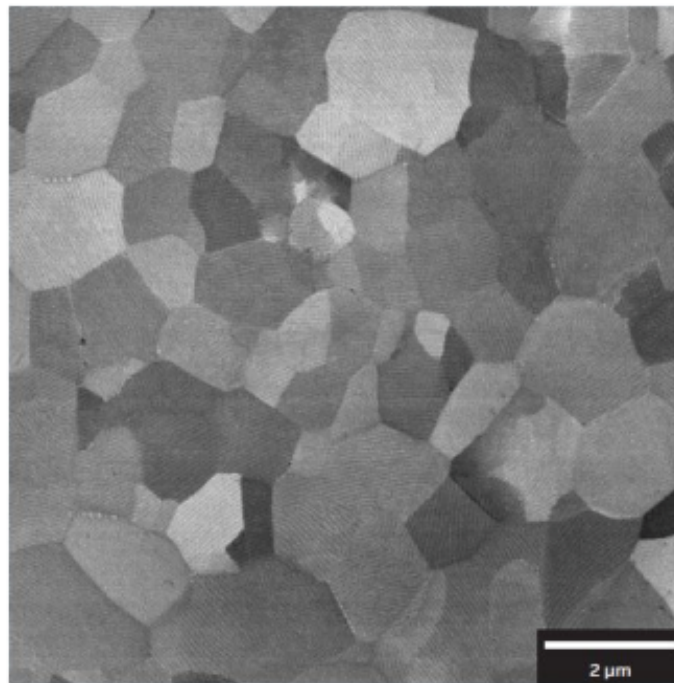

Figure 2: SEM image of a metal sample showing grain structures. Image from [\[https://www.tescan.com/sem-and-ebstd-analysis-of-the-grain-structure-after-ecap-process-of-the-aluminum-material/\]](https://www.tescan.com/sem-and-ebstd-analysis-of-the-grain-structure-after-ecap-process-of-the-aluminum-material/)

You are trying to analyze a sample of metal to obtain the average size of its grain structure. The image above shows an SEM capture of the grain structure in metals. When scanning across the surface of the material with an AFM, the image comes out smooth and uniform with no signs of grains. You realized that grains in metals have slight variations in mechanical properties. How would you use the AFM and the force distance curve to obtain an image similar to Figure 2?

- a. Obtain the FD curve at six points and average it.

- b. Obtain the FD curve at multiple points and plot a characteristic data point from that curve.
- c. Obtain the FD curve at multiple points and plot the slope of the repulsive region.
- d. Obtain the FD curve at multiple points and plot the slope of the attractive region.

Appendix C: Assessment 2

Thank you for participating in the AFM lab!

Now that you have completed all activities, you are required to complete another series of questions. The purpose of these questions is to 1) assess your learning experience and understanding of the AFM force distance curve, and 2) examine the learning effectiveness of instruction in this course. In order for this to be an effective analysis, we need you to answer **all** the questions on your own based on your present knowledge; do not consult the internet, peers, etc. for the answers.

Completion of these questions is mandatory for the AFM lab, but your performance on these questions is not graded. Your identity will be anonymized in any data analysis that we perform. Thank you!

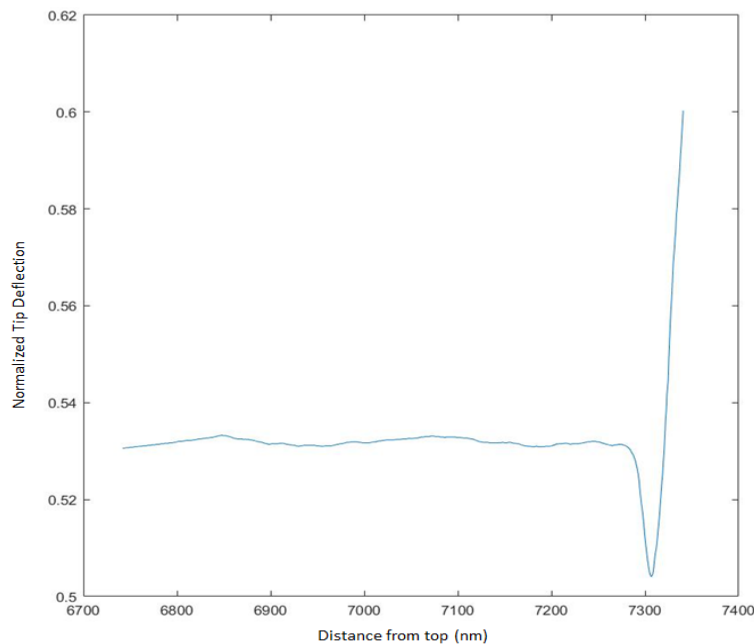

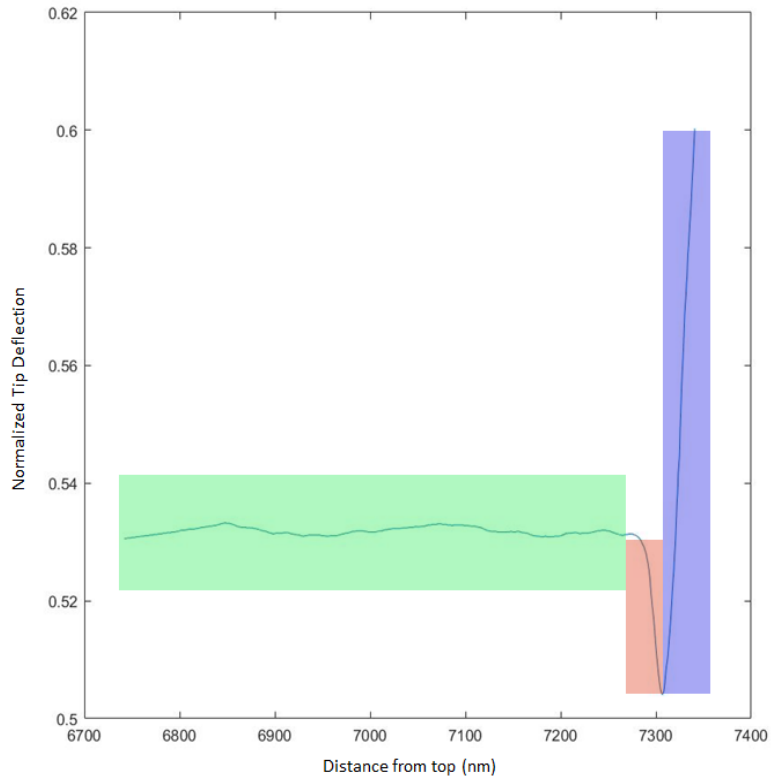

Figure 1: Left plot: FD curve; Right plot: same FD curve with different colored sections

Attached above is the same FD curve from assessment 1. Suppose this FD curve was for a piece of plastic and you were asked to compare it to the FD curve from a piece of copper.

1. What is the main change you would expect to see in the FD curve?
 - a. Change in magnitude of green section.
 - b. Change in magnitude of red section.
 - c. Change in magnitude of blue section.

2. Would there be an increase or decrease in magnitude of the selected section?
 - a. Increase
 - b. Decrease

3. Why do you think this change happens?
 - a. Steel is more conductive than plastic, so it has a stronger repulsive force with the tip.
 - b. Steel is more conductive than plastic, so it has a weaker repulsive force with the tip.
 - c. Steel is more conductive than plastic, so it has a stronger attractive force with the tip.
 - d. Steel is more conductive than plastic, so it has a weaker attractive force with the tip.

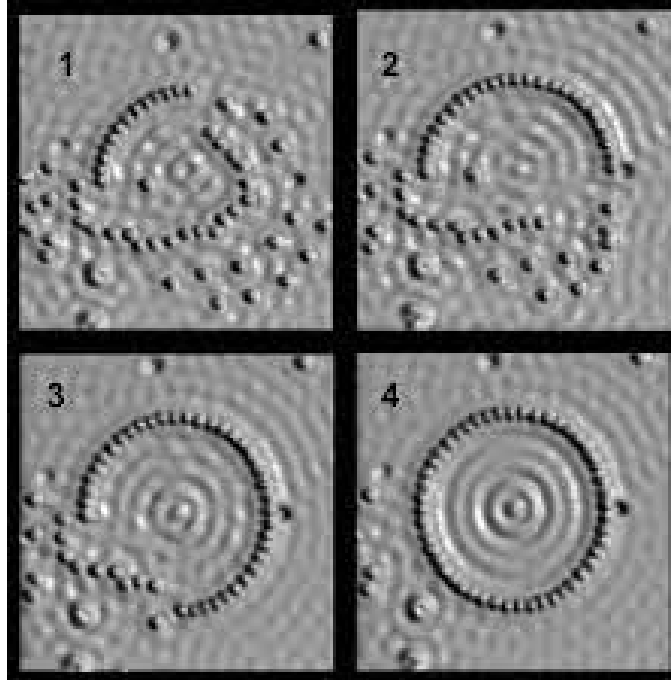

Figure 2: Image showing the progression of picking and placing individual iron atoms on a copper substrate in a circle using an STM [12]

So far, we have only thought about the AFM as a means to scan and measure material surfaces. In the field of nanotechnology, AFMs are also used to manipulate materials on surfaces. For example, you can move nanospheres around a surface, like a claw machine at arcades. This is done by creating an attraction between the AFM tip and the nanosphere by supplying a voltage difference between them. Name the force that would cause this attraction?

- a. Coulomb Force
- b. Van der Waals Force
- c. Strong Nuclear Force
- d. Weak Nuclear Force

This is the working principle of the scanning tunneling microscope (STM) which was invented at IBM in 1981. If you are interested in learning more, IBM has released a stop-motion animation done by manipulating carbon monoxide molecules with an STM titled “A boy and his Atom.”

Appendix D: Survey Response and Feedback Questions

Please reflect on your haptics and visualization learning experience and answer the following questions. The answer scale ranges from 1-7 where 1 = *not at all true of me* and 7 = *Very true of me*.

1. I liked learning about the AFM using haptics and visualization. (1-7 scale)
2. I would prefer to learn about the AFM using the haptics and visualization as opposed to traditional text and graphics. (1-7 scale)
3. I learned the necessary material using haptics and visualization. (1-7 scale)

4. How did using haptics and visualization you received facilitate or detract from your learning?
5. Any feedback or additional comments?

Appendix E: Feedback Responses

How did using haptics and visualization you received facilitate or detract from your learning?	Any feedback or additional comments?
It gave me an intuition for what the tip senses as it approaches a surface. The red dot helped understand what part of the curve I was in.	Can we have the answer after the activity, so we know if our conjecture was correct or not?
It was very supplemental in a good way	A little visual clarifying the axes in part I would have been helpful
I thought it was very interesting to learn about haptics in this way. I didn't have much background about it before and found it fun!	The instructions for the tutorial were clear but the connection between the forces and the types of materials were a little unclear. It would have been more helpful, in my opinion, to show an example graph with the explanations of the forces.
It was fun so that made it engaging but the device was finicky so that made it a little confusing to understand what was going on. A better understanding of what the device actually is and how it operates might be nice so that I could understand why I was feeling what I was feeling.	
It gave me a much more physical understanding of the process	
It gave me a more intuitive sense of what the AFM was experiencing, which made it easier to understand how it functioned.	